



VVF22..



VXF22..

ACVATIX™

## 2- and 3-port valves with flanged connections, PN 6

VVF22..  
VXF22..

From the large-stroke valve line

- Performance valves for medium temperatures from -10...130 °C
- Valve body of grey cast iron EN-GJL-250
- DN 25...100
- $k_{vs}$  2.5...160 m<sup>3</sup>/h
- Flange type 21, flange design B
- Equipable with electro-motoric actuators SAX.. or electro-hydraulic actuators SKD.., SKB.., SKC..











### Use

In boiler, refrigeration plants, heating groups, ventilation and air-handling units as control or shutoff valves.

For use in closed circuits.

## Type summary

| Valves  | Actuators<br>Stroke<br>Positioning force<br>Data sheet |                     |          |       | SAX..        | SKD..            | SKB..        | SKC..            |              |                  |              |                  |
|---|--|---------------------|----------|-------|--------------|------------------|--------------|------------------|--------------|------------------|--------------|------------------|
|   |  |                     |          |       | 20 mm        |                  |              |                  | 40 mm        |                  |              |                  |
| PN 6  |  |                     |          |       | 800 N        | 1000 N           | 2800 N       | 2800 N           |              |                  |              |                  |
|  | Stock number   | DN                  | $k_{vs}$ | $S_v$ | $\Delta p_s$ | $\Delta p_{max}$ | $\Delta p_s$ | $\Delta p_{max}$ | $\Delta p_s$ | $\Delta p_{max}$ | $\Delta p_s$ | $\Delta p_{max}$ |
|   |  | [m <sup>3</sup> /h] | [kPa]    |       |              |                  |              |                  |              |                  |              |                  |
| -10...130 °C  |  |                     |          |       |              |                  |              |                  |              |                  |              |                  |
| VVF22.25-2.5  | S55200-V100  | 25                  | 2.5      | > 50  | 600          | 300              | 600          | 300              | 600          | 300              | -            | -                |
| VVF22.25-4  | S55200-V101  | 25                  | 4        |       |              |                  |              |                  |              |                  |              |                  |
| VVF22.25-6.3  | S55200-V102  | 25                  | 6.3      |       |              |                  |              |                  |              |                  |              |                  |
| VVF22.25-10   | S55200-V103  | 25                  | 10       |       |              |                  |              |                  |              |                  |              |                  |
| VVF22.40-16   | S55200-V104  | 40                  | 16       | > 100 | 550          | -                | -            | -                | -            | -                | -            | -                |
| VVF22.40-25   | S55200-V105  | 40                  | 25       |       |              |                  |              |                  |              |                  |              |                  |
| VVF22.50-40   | S55200-V106  | 50                  | 40       |       |              |                  |              |                  |              |                  |              |                  |
| VVF22.65-63   | S55200-V107  | 65                  | 63       |       |              |                  |              |                  |              |                  |              |                  |
| VVF22.80-100 <sup>1)</sup>  | S55200-V108  | 80                  | 100      |       |              |                  |              |                  |              |                  |              |                  |
| VVF22.100-160 <sup>1)</sup>   | S55200-V109  | 100                 | 160      |       |              |                  |              |                  |              |                  |              |                  |
|   |  |                     |          |       |              |                  |              |                  |              |                  |              |                  |

| Valves  | Actuators<br>Stroke<br>Positioning force<br>Data sheet |                     |          |       | SAX..   | SKD..   | SKB..   | SKC..   |  |   |   |   |   |
|---|--|---------------------|----------|-------|---|---|---|---|--|---|---|---|---|
|   |  |                     |          |       | 20 mm   |   |   |   | 40 mm  |   |   |   |   |
| PN 6  |  |                     |          |       | 800 N   | 1000 N  | 2800 N  | 2800 N  |  |   |   |   |   |
|  | Stock number   | DN                  | $k_{vs}$ | $S_v$ | $\Delta p_{max}$  |   |   |   |  |   |   |   |   |
|   |  | [m <sup>3</sup> /h] | [kPa]    |       |   |   |   |   |  |   |   |   |   |
| -10...130 °C  |  |                     |          |       |  |  |  |  |  |  |  |  |  |
| VXF22.25-2.5  | S55200-V110  | 25                  | 2.5      | > 50  | 300   | 100   | 300   | 100   | 300  | 100   | -   | -   |   |
| VXF22.25-4  | S55200-V111  | 25                  | 4        |       |   |   |   |   |  |   |   |   |   |
| VXF22.25-6.3  | S55200-V112  | 25                  | 6.3      |       |   |   |   |   |  |   |   |   |   |
| VXF22.25-10   | S55200-V113  | 25                  | 10       |       |   |   |   |   |  |   |   |   |   |
| VXF22.40-16   | S55200-V114  | 40                  | 16       | > 100 | -   | -   | -   | -   | -  | -   | -   | -   |   |
| VXF22.40-25   | S55200-V115  | 40                  | 25       |       |   |   |   |   |  |   |   |   |   |
| VXF22.50-40   | S55200-V116  | 50                  | 40       |       |   |   |   |   |  |   |   |   |   |
| VXF22.65-63   | S55200-V117  | 65                  | 63       |       |   |   |   |   |  |   |   |   |   |
| VXF22.80-100 <sup>1)</sup>  | S55200-V118  | 80                  | 100      |       |   |   |   |   |  |   |   |   |   |
| VXF22.100-160 <sup>1)</sup>   | S55200-V119  | 100                 | 160      |       |   |   |   |   |  |   |   |   |   |
|   |  |                     |          |       |   |   |   |   |  |   |   |   |   |

<sup>1)</sup> Valve characteristic for  $k_{vs}$  value 100 m<sup>3</sup>/h from 70% stroke,  $k_{vs}$  value 160 m<sup>3</sup>/h from 85% is optimized for maximum volumetric flow

DN = Nominal size

$k_{vs}$  = Flow nominal value of cold water (5...30 °C) through the fully opened valve ( $H_{100}$ ) at a differential pressure of 100 kPa (1 bar)

$S_v$  = Rangeability

$\Delta p_s$  = Maximum permissible differential pressure at which the motorized valve still closes securely against the pressure

$\Delta p_{max}$  = Maximum permissible differential pressure across the valve's throughport for the entire positioning range of the motorized valve

## Ordering

### Example

| Product number | Stock number | Description                    |
|----------------|--------------|--------------------------------|
| VVF22.25-2.5   | S55200-V100  | 2-port valve with flange, PN 6 |
| SKD32.50       | SKD32.50     | Electro-hydraulic actuator     |

Delivery

Valves, actuators and accessories are packed and delivered as separate items.

Note

Counter-flanges, bolts and gaskets must be provided on site.

Spare parts, Rev.-No.

See page 11

### Equipment combinations

| Product number | Description      | Stroke     | Positioning force                   | Operating voltage  | Positioning signal                  | Spring return time | Positioning time | LED | Manual adjuster              | Auxiliary functions |                              |                                 |       |
|----------------|------------------|------------|-------------------------------------|--------------------|-------------------------------------|--------------------|------------------|-----|------------------------------|---------------------|------------------------------|---------------------------------|-------|
| SAX31.00       | S55150-A105      | 20 mm      | 800 N                               | AC 230 V           | 3-position                          | -                  | 120 s            | -   | Press and fix                | 1)                  |                              |                                 |       |
| SAX31.03       | S55150-A106      |            |                                     |                    |                                     |                    | 30 s             | ✓   |                              |                     | 2), 3)                       |                                 |       |
| SAX61.03       | S55150-A100      |            |                                     | AC 24 V<br>DC 24 V | 0...10 V<br>4...20 mA<br>0...1000 Ω |                    | 120 s            | -   |                              | 1)                  |                              |                                 |       |
| SAX61.03U      | S55150-A100-A100 |            |                                     |                    |                                     |                    | 30 s             | -   |                              |                     |                              |                                 |       |
| SAX81.00       | S55150-A102      |            |                                     | 3-position         | -                                   |                    | -                | -   |                              | -                   | -                            | -                               | -     |
| SAX81.03       | S55150-A103      |            |                                     |                    |                                     |                    |                  |     |                              |                     |                              |                                 |       |
| SAX81.03U      | S55150-A103-A100 |            |                                     |                    |                                     |                    |                  |     |                              |                     |                              |                                 |       |
| SKD32.21       | SKD32.21         | 20 mm      | 1000 N                              | AC 230 V           | 3-position                          | -                  | 8 s              | -   | Turn, Position is maintained | 1)                  |                              |                                 |       |
| SKD32.50       | SKD32.50         |            |                                     |                    |                                     |                    | 120 s            |     |                              |                     |                              |                                 |       |
| SKD32.51       | SKD32.51         |            |                                     |                    |                                     |                    | 8 s              |     |                              |                     |                              |                                 |       |
| SKD60          | SKD60            |            |                                     | AC 24 V            | 0...10 V<br>4...20 mA<br>0...1000 Ω | -                  | -                | -   | -                            | -                   | -                            |                                 |       |
| SKD62          | SKD62            |            |                                     |                    |                                     |                    |                  |     |                              |                     |                              | 15 s                            | ✓     |
| SKD62U         | SKD62U           |            |                                     | 3-position         | -                                   | -                  | -                | -   | -                            | -                   | -                            |                                 |       |
| SKD62UA        | SKD62UA          |            |                                     |                    |                                     |                    |                  |     |                              |                     |                              | 8 s                             | 120 s |
| SKD82.50       | SKD82.50         |            |                                     | 20 mm              | 2800 N                              | AC 230 V           | 3-position       | -   | 120 s                        | -                   | Turn, Position is maintained | 1)                              |       |
| SKD82.50U      | SKD82.50U        |            |                                     |                    |                                     |                    |                  |     |                              |                     |                              |                                 | 10 s  |
| SKB60          | SKB60            |            |                                     |                    |                                     |                    |                  |     |                              |                     |                              |                                 | 10 s  |
| SKB62          | SKB62            | AC 24 V    | 0...10 V<br>4...20 mA<br>0...1000 Ω |                    |                                     | -                  | -                | -   | -                            | -                   |                              |                                 |       |
| SKB62U         | SKB62U           |            |                                     |                    |                                     |                    |                  |     |                              |                     | 10 s                         | 120 s                           | 1)    |
| SKB62UA        | SKB62UA          | 3-position | -                                   |                    |                                     | -                  | -                | -   | -                            | -                   | -                            |                                 |       |
| SKB82.50       | SKB82.50         |            |                                     | 10 s               | 120 s                               |                    |                  |     |                              |                     |                              | 1)                              |       |
| SKB82.50U      | SKB82.50U        |            |                                     |                    |                                     |                    |                  |     |                              |                     |                              |                                 |       |
| SKB82.51       | SKB82.51         | 40 mm      | 2800 N                              | AC 230 V           | 3-position                          | -                  | 120 s            | -   | Turn, Position is maintained | 1)                  |                              |                                 |       |
| SKB82.51U      | SKB82.51U        |            |                                     |                    |                                     |                    |                  |     |                              |                     | 18 s                         |                                 |       |
| SKC32.60       | SKC32.60         |            |                                     |                    |                                     |                    |                  |     |                              |                     | 18 s                         | 120 s                           | -     |
| SKC32.61       | SKC32.61         |            |                                     | AC 24 V            | 0...10 V<br>4...20 mA<br>0...1000 Ω | -                  | -                | -   | -                            | -                   |                              |                                 |       |
| SKC60          | SKC60            |            |                                     |                    |                                     |                    |                  |     |                              |                     | 20 s                         | Opening: 120 s<br>Closing: 20 s | ✓     |
| SKC62          | SKC62            |            |                                     | 3-position         | -                                   | -                  | -                | -   | -                            | -                   | -                            |                                 |       |
| SKC62U         | SKC62U           | 18 s       | 120 s                               |                    |                                     |                    |                  |     |                              |                     |                              | 1)                              |       |
| SKC62UA        | SKC62UA          |            |                                     |                    |                                     |                    |                  |     |                              |                     |                              |                                 |       |
| SKC82.60       | SKC82.60         | 3-position | -                                   | -                  | -                                   | -                  | -                | -   | -                            |                     |                              |                                 |       |
| SKC82.60U      | SKC82.60U        |            |                                     |                    |                                     |                    |                  |     |                              | 18 s                | 120 s                        | 1)                              |       |
| SKC82.61       | SKC82.61         |            |                                     |                    |                                     |                    |                  |     |                              |                     |                              |                                 |       |
| SKC82.61U      | SKC82.61U        |            |                                     |                    |                                     |                    |                  |     |                              |                     |                              |                                 |       |

- 1) Auxiliary switch, potentiometer
- 2) Position feedback, forced control, selection of valve characteristic
- 3) Optional: sequence control, selection of acting direction
- 4) Plus sequence control, stroke limitation, and selection of acting direction

**Product documentation**

- Mounting Instructions M4030 74 319 0749 0
- Basic documentation P4030 Contains background information and technical basic knowledge of valves

**Technical and mechanical design**

The illustrations below show the basic design of the valves. Constructional features, such as the shape of plugs, may differ.

**2-port valves**

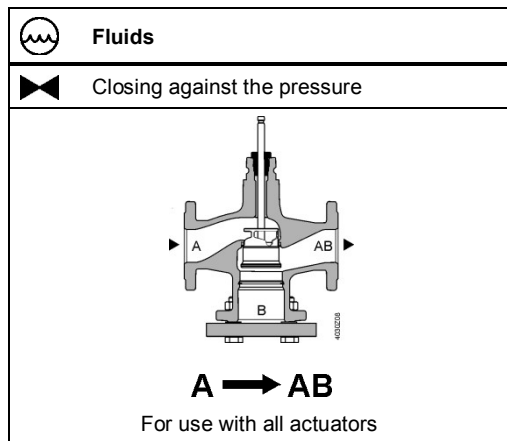

Note

**2-port valves do not become 3-port valves by removing the blank flange!**

**3-port valves**

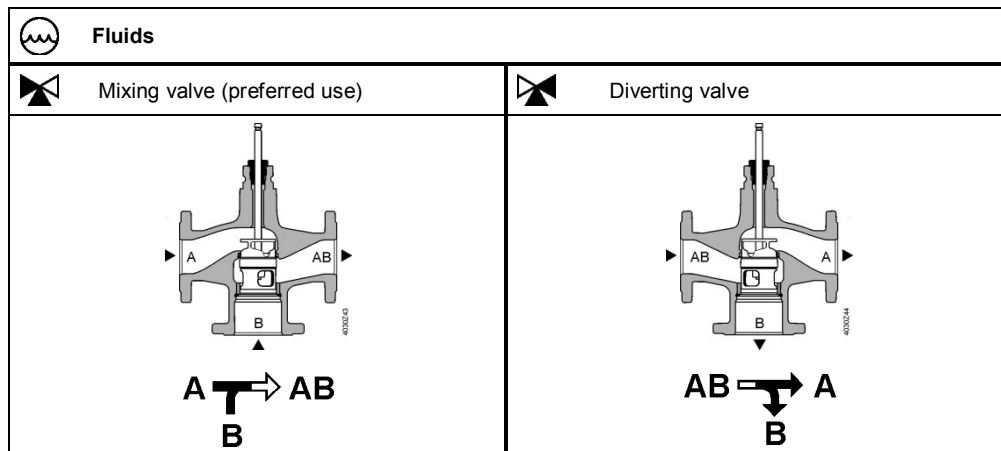

## Accessories

| Product number | Stock number | Description          | Note                                    | Example   |
|----------------|--------------|----------------------|---|---|
| ASZ6.5         | ASZ6.5       | Stem heating element | Required for medium temperatures < 0 °C |  |
| ASZ6.6         | S55845-Z108  |                      |   |   |

## Sizing

### Flow chart

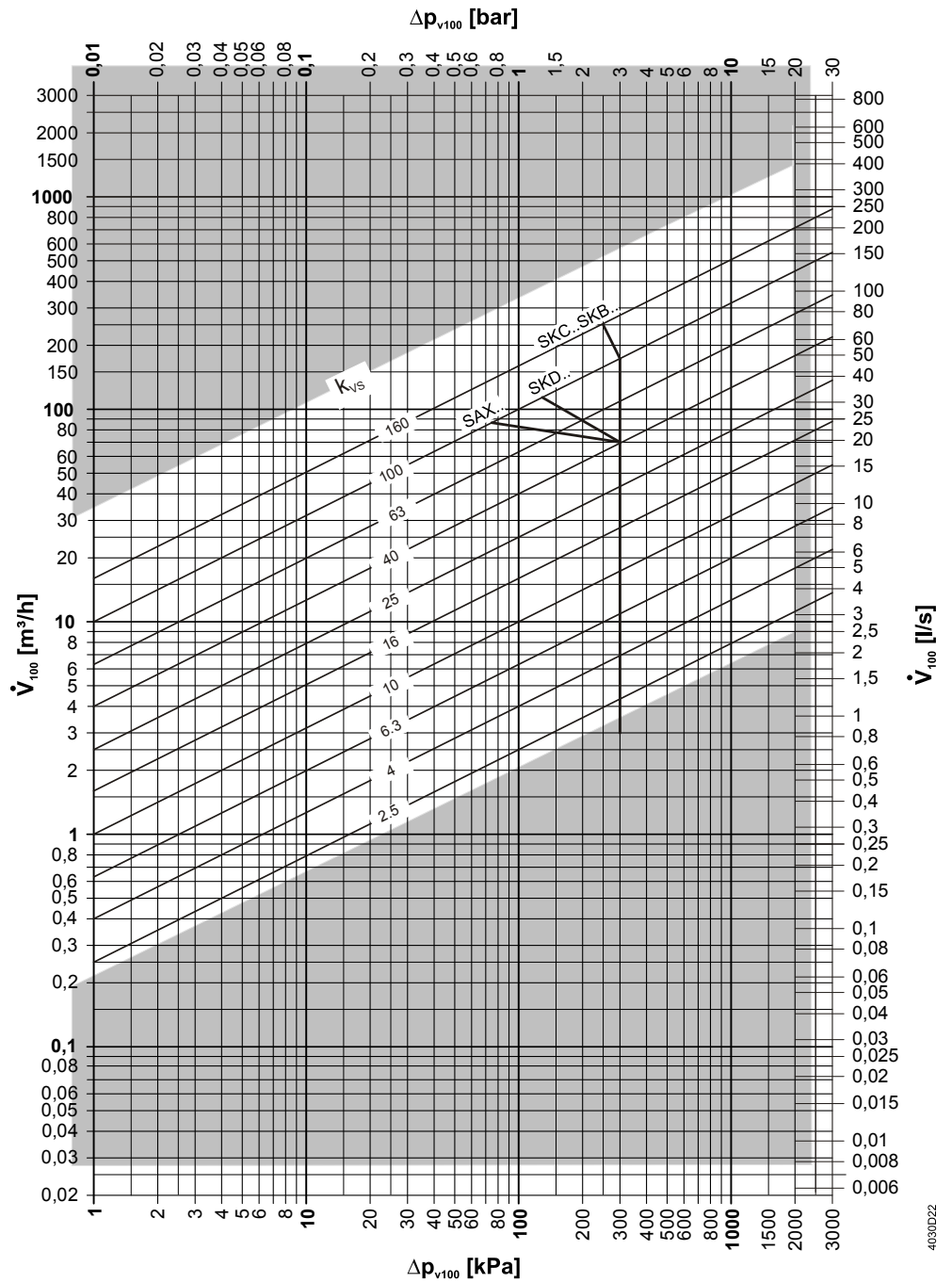

$\Delta p_{\text{max}}$  values apply for the mixing function.  $\Delta p_{\text{max}}$  values for the diverting function see table „Type summary“, page 2.

4030022

## Valve characteristics 2-port valves

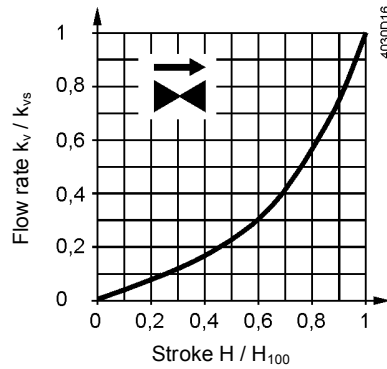

0...30%: Linear  
30...100%: Equal percentage  
 $n_{gl} = 3$  to VDI / VDE 2173

For high  $k_{vs}$  values the valve characteristic is optimized for maximum volumetric flow  $k_{V100}$ .

## 3-port valves

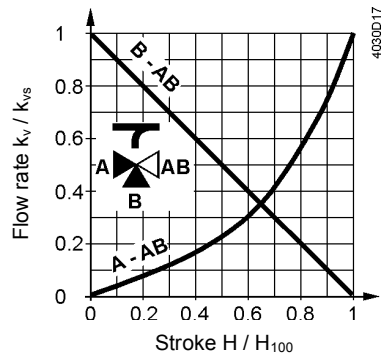

### Throughport A-AB

0...30%: Linear  
30...100%: Equal percentage  
 $n_{gl} = 3$  to VDI / VDE 2173

For high  $k_{vs}$  values the valve characteristic is optimized for maximum volumetric flow  $k_{V100}$ .

### Bypass B-AB

0...100%: Linear  
Tor AB = constant flow  
Tor A = variable flow  
Tor B = bypass (variable flow)

**Mixing:** Flow from port A and port B to port AB  
**Diverting:** Flow from port AB to port A and port B

## Operating pressure and medium temperature

Fluids, PN6  
with V..F22..

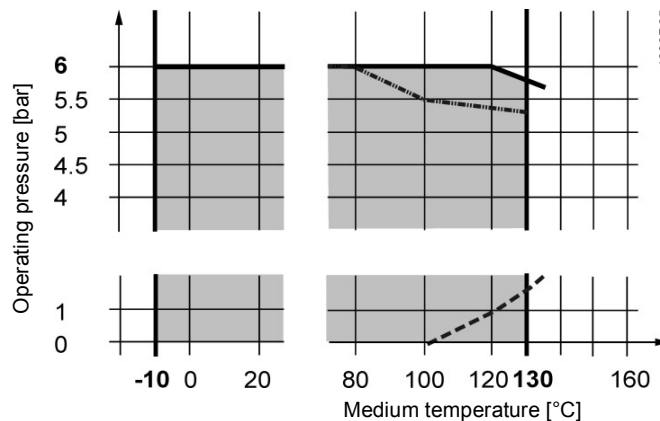

--- Curve for saturated steam; steam forms below this line  
Operating pressure according to EN 1092, valid for 2-port valves with  
- · · blank flange

## Operating pressure and operating temperatures according to ISO 7005, EN 1092 and EN 12284

Notes

All relevant local directives must be observed

**Medium compatibility and temperature ranges**

| Medium   | Temperature range     |                       | Valve | Note   |
|--|-----------------------|-----------------------|-------|--|
|  | T <sub>min</sub> [°C] | T <sub>max</sub> [°C] |       |  |
| Cold water   | 1                     | 25                    | ■     | -  |
| Low-temperature hot water                                | 1                     | 130                   | ■     | -  |
| High-temperature hot water                               | 130                   | 150                   | -     | -  |
| Water with antifreeze                                    | -5                    | 130                   | ■     | For medium temperatures below 0 °C, the stem heating ASZ6.6 has to be installed. |
|  | -10                   | 130                   | ■     |  |
| Brines   | -5                    | 130                   | ■     | For medium temperatures below 0 °C, the stem heating ASZ6.6 has to be installed. |
|  | -10                   | 130                   | ■     |  |
| Demineralized water according to VDI2035 / SWKI_BT102-01 | 1                     | 130                   | ■     |  |

<sup>1)</sup> Differentiation due to saturated steam curve

**Fields of use**

| Fields of use       |                                    | Valves  |         |
|---------------------|------------------------------------|---------|---------|
|                     |                                    | VVF22.. | VXF22.. |
| <b>Generation</b>   | Boiler plants                      | ■       | ■       |
|                     | Refrigeration plants               | ■       | ■       |
| <b>Distribution</b> | Heating groups                     | ■       | ■       |
|                     | Ventilation and air-handling units | ■       | ■       |

**Engineering notes**

- Mounting location** Preferably mount the valves at the return, as the temperature is lower there and the strain on the stem sealing gland is lower.
- Dirt trap** Mount a dirt filter or dirt trap before the valve to ensure proper functioning, and a long service life of the valve. Remove dirt, welding beads, etc. from the valves and pipes.
- Cavitation** Cavitation can be avoided by limiting the pressure differential across the valve depending on the medium temperature and prepressure.

**Mounting notes**

**Mounting position**

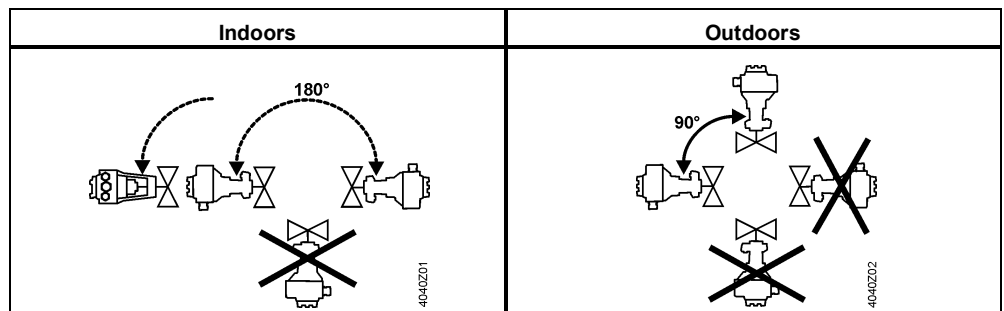

Mounting positions apply to both 2- and 3-port valves.

**Commissioning notes**



**The valve may be put into operation only if actuator and valve are correctly assembled.**

**Note**

Ensure that actuator stem and valve stem are rigidly connected in all positions.

## Function check

| Valve               | Throughport A→AB | Bypass B→AB |
|---------------------|------------------|-------------|
| Valve stem extends  | Closes           | Opens       |
| Valve stem retracts | Opens            | Closes      |

## Maintenance notes

---

The valves are maintenance-free.



When servicing valves or actuators:

- Deactivate the pump and turn off the power supply
- Close the shutoff valves
- Fully reduce the pressure in the piping system and allow pipes to completely cool down

If necessary, disconnect the electrical wires.

Due to the different types of material used, the valve must be disassembled prior to disposal. Special handling of certain valve components may be required by law or may be sensible from an ecological point of view.

**Local and currently valid legislation must be observed.**

## Disposal



## Warranty

---

Application-related technical data are guaranteed only when the valves are used in connection with the Siemens actuators listed under "Equipment combinations", page 3.

When used with actuators of other manufacture, any warranty by Siemens becomes void.



## Technical data

|                    |   |   |  |
|--------------------|---|---|--|
| Functional data    | PN class  | PN 6  |  |
|                    | Connection  | Flange  |  |
|                    | Operating pressure  | See Section "Operating pressure and medium temperatures", page 11 |  |
|                    | Valve characteristics <sup>1)</sup>   | See section "Valve characteristics", page 6                       |  |
|                    | Leakage rate  | Throughport   | 0...0.02% of $k_{vs}$ value  |
|                    |   | Bypass  | 0.5...2% of $k_{vs}$ value ( $k_{vs} \geq 6.3$ )<br>0.5...4% of $k_{vs}$ value ( $k_{vs} 2.5; 4$ ) |
|                    | Permissible media   | See table " Medium compatibility and temperature ranges", page 7  |  |
|                    | Medium temperature  | -10...130 °C  |  |
|                    | Rangeability  | To DN 25: > 50<br>From DN 40: >100                                |  |
|                    | Nominal stroke  | To DN 80: 20 mm<br>From DN 100: 40 mm                             |  |
|                    | Materials   | Valve body  | EN-GJL-250   |
| Blank flange       |   | VVF.. S235JRG2  |  |
| Valve stem         |   | Stainless steel   |  |
| Seat               |   | Machined  |  |
| Plug               |   | Brass/ Bronze   |  |
| Stem sealing gland |   | Brass<br>EPDM O-rings<br>PTFE sleeve<br>silicon-free              |  |
| Standards          | Pressure Equipment Directive  | PED 97/23/EC  |  |
|                    | Pressure-carrying accessories   | According to article 1, section 2.1.4                             |  |
|                    | Fluid group 2   | PN 6  |  |
|                    | Without CE certification as per article 3, section 3 (sound engineering practice) | ≤ DN 100  |  |
|                    | Category I, with CE certification   | -   |  |
|                    | Category II, with CE certification, notified body identification number 0036      | -   |  |
|                    | PN class  | ISO 7268  |  |
|                    | Operating pressure  | ISO 7005, DIN EN 12284  |  |
|                    | Flanges   | ISO 7005  |  |
|                    | Length of flanged valves  | DIN EN 558-1, line 1  |  |
|                    | Valve characteristic  | VDI 2173 <sup>1)</sup>  |  |
|                    | Leakage rate  | Throughport, bypass according to EN 60534-4 / EN 1349             |  |
|                    | Water treatment   | VDI 2035  |  |

|                             |   |                           |
|-----------------------------|---|---------------------------|
| Environmental conditions    |   |                           |
| Storage: IEC 60721-3-1      | Class   | 1K3                       |
|                             | Temperature   | -15...+55 °C              |
|                             | Rel. humidity   | 5...95% r.h.              |
| Transport: IEC 60721-3-2    | Class   | 2K3, 2M2                  |
|                             | Temperature   | -30...+65 °C              |
|                             | Rel. humidity   | < 95% r.h.                |
| Operation: IEC 60721-3-3    | Class   | 3K5, 3Z11                 |
|                             | Temperature   | -15...+55 °C              |
|                             | Rel. humidity   | 5...95% r.h.              |
| Environmental compatibility | ISO 14001 (environment)<br>ISO 9001 (quality)<br>SN 36350 (environmentally compatible products)<br>RL 2002/95/EG (RoHS) |                           |
| Dimensions / Weight         | Dimensions  | See „Dimensions“, page 11 |
|                             | Weight  | See „Dimensions“, page 11 |

<sup>1)</sup> For certain valve lines and high  $k_{vs}$  values, the valve characteristic is optimized for maximum volumetric flow  $k_{V100}$ .

## Dimensions

### VVF22..

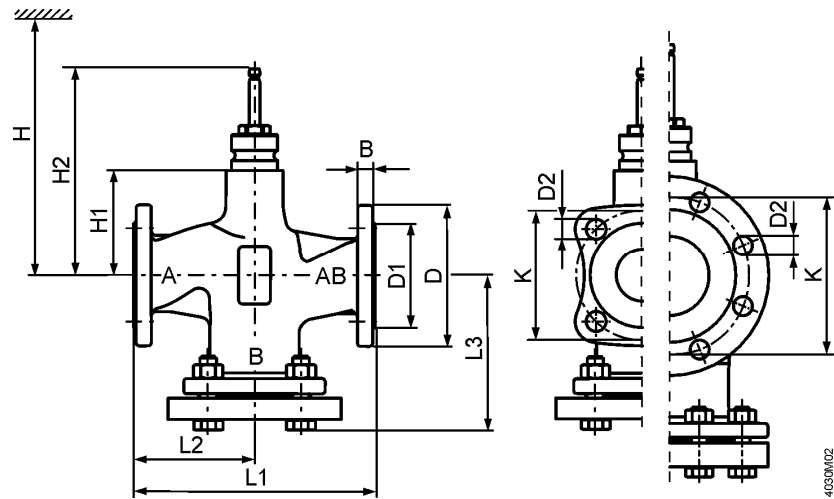

| Product number | DN  | kg   | B  | Ø D | Ø D1 | Ø D2    | L1  | L2  | L3    | Ø K | H1  | H2    | H     |       |       |       |
|----------------|-----|------|----|-----|------|---------|-----|-----|-------|-----|-----|-------|-------|-------|-------|-------|
|                |     |      |    |     |      |         |     |     |       |     |     |       | SAX.. | SKD.. | SKB.. | SKC.. |
| VVF22..        | 25  | 4.1  | 11 | 100 | 58   | 11 (4x) | 150 | 75  | 99    | 75  | 37  | 133.5 | 479   | 537   | 612   | -     |
|                | 40  | 6.5  | 13 | 130 | 78   | 14 (4x) | 180 | 90  | 116   | 100 | 37  | 133.5 | 479   | 537   | 612   | -     |
|                | 50  | 8    | 14 | 140 | 88   | 14 (4x) | 200 | 100 | 128   | 110 | 50  | 146.5 | 492   | 550   | 625   | -     |
|                | 65  | 11.9 | 14 | 160 | 108  | 14 (4x) | 240 | 120 | 142.5 | 130 | 75  | 171.5 | 517   | 575   | 650   | -     |
|                | 80  | 17.1 | 16 | 190 | 124  | 19 (4x) | 260 | 130 | 157   | 150 | 75  | 171.5 | 517   | 575   | 650   | -     |
|                | 100 | 23.8 | 16 | 210 | 144  | 19 (4x) | 300 | 150 | 179   | 170 | 110 | 226.5 | -     | -     | -     | 685   |

### VXF22..

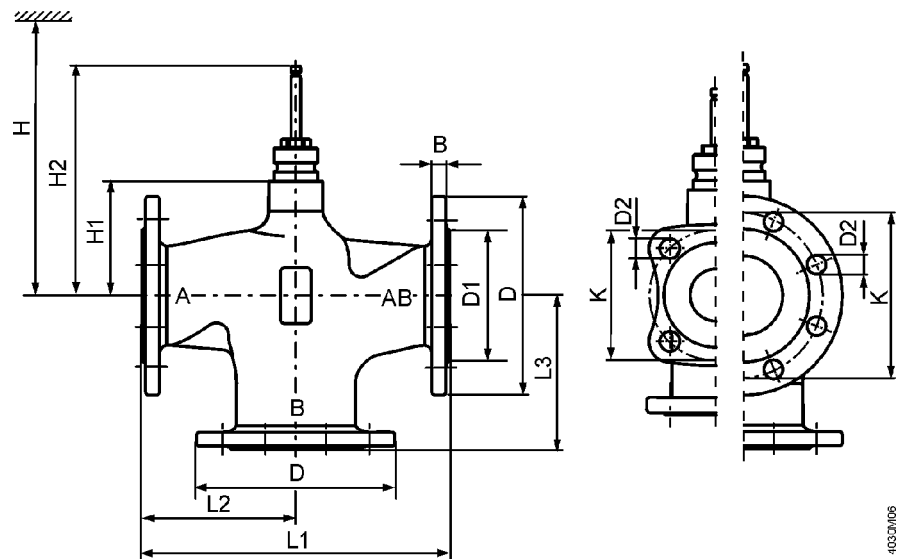

| Product number | DN  | kg   | B  | Ø D | Ø D1 | Ø D2    | L1  | L2  | L3  | Ø K | H1  | H2    | H     |       |       |       |
|----------------|-----|------|----|-----|------|---------|-----|-----|-----|-----|-----|-------|-------|-------|-------|-------|
|                |     |      |    |     |      |         |     |     |     |     |     |       | SAX.. | SKD.. | SKB.. | SKC.. |
| VXF22..        | 25  | 3.1  | 11 | 100 | 58   | 11 (4x) | 150 | 75  | 75  | 75  | 37  | 133.5 | 479   | 537   | 612   | -     |
|                | 40  | 4.9  | 13 | 130 | 78   | 14 (4x) | 180 | 90  | 90  | 100 | 37  | 133.5 | 479   | 537   | 612   | -     |
|                | 50  | 6.2  | 14 | 140 | 88   | 14 (4x) | 200 | 100 | 100 | 110 | 50  | 146.5 | 492   | 550   | 625   | -     |
|                | 65  | 9.5  | 14 | 160 | 108  | 14 (4x) | 240 | 120 | 120 | 130 | 75  | 171.5 | 517   | 575   | 650   | -     |
|                | 80  | 13.1 | 16 | 190 | 124  | 19 (4x) | 260 | 130 | 130 | 150 | 75  | 171.5 | 517   | 575   | 650   | -     |
|                | 100 | 19   | 16 | 210 | 144  | 19 (4x) | 300 | 150 | 150 | 170 | 110 | 226.5 | -     | -     | -     | 685   |

## Spare parts

### Stem sealing gland

| Product number     | DN          | Stock number | Comments |
|--------------------|-------------|--------------|----------|
| VVF22..<br>VXF22.. | DN 15...150 | 4 284 8806 0 |          |



### Revision numbers

VVF..  
VXF..

| Product number | Valid from rev. no. | Product number | Valid from rev. no. |
|----------------|---------------------|----------------|---------------------|
| VVF22.25-2.5   | ..A                 | VXF22.25-2.5   | ..A                 |
| VVF22.25-4     | ..A                 | VXF22.25-4     | ..A                 |
| VVF22.25-6.3   | ..A                 | VXF22.25-6.3   | ..A                 |
| VVF22.25-10    | ..A                 | VXF22.25-10    | ..A                 |
| VVF22.40-16    | ..A                 | VXF22.40-16    | ..A                 |
| VVF22.40-25    | ..A                 | VXF22.40-25    | ..A                 |
| VVF22.50-40    | ..A                 | VXF22.50-40    | ..A                 |
| VVF22.65-63    | ..A                 | VXF22.65-63    | ..A                 |
| VVF22.80-100   | ..A                 | VXF22.80-100   | ..A                 |
| VVF22.100-160  | ..A                 | VXF22.100-160  | ..A                 |