



VVF53..
VVF53..K



VXF53..

ACVATIX™

2- and 3-port valves with flanged connections, PN 25

VVF53..
VXF53..

From the large-stroke valve line

- High-performance valves for medium temperatures from -20...220 °C
- Valve body of nodular cast iron EN-GJS-400-18-LT
- DN 15...150
- k_{vs} 0.16...400 m³/h
- Flange type 21, flange design B
- VVF53..K with pressure compensation to handle high differential pressure
- Equipable with electro-motoric actuators SAX.. or electro-hydraulic actuators SKD.., SKB.., SKC..

Use

In boiler, district heating and refrigeration plants, cooling towers, heating groups, and in air handling units as control or shutoff valves.
For use in closed or open hydraulic circuits (observe cavitation).

Type summary

Valves	Actuators				SAX.. ⁴⁾		SKD.. ²⁾		SKB..		SKC..	
	Stroke				20 mm		20 mm		20 mm		40 mm	
	Positioning force				800 N		1000 N		2800 N		2800 N	
PN 25 PN 16 ¹⁾	Data sheet				N4501		N4561		N4664		N4566	
	Stock no.	DN	k _{vs} [m ³ /h]	S _v	Δp _s	Δp _{max}	Δp _s	Δp _{max}	Δp _s	Δp _{max}	Δp _s	Δp _{max}
[kPa]												
Fluids Preferred flow direction A-AB with fluids for low noise operation and high k _{vs} -values with all actuator types	VVF53.15-0.16	S55208-V100	15	0.16	> 50	2500	1200	2500	1200	2500	-	-
	VVF53.15-0.2	S55208-V101	15	0.2								
	VVF53.15-0.25	S55208-V102	15	0.25								
	VVF53.15-0.32	S55208-V103	15	0.32								
	VVF53.15-0.4	S55208-V104	15	0.4								
	VVF53.15-0.5	S55208-V105	15	0.5								
	VVF53.15-0.63	S55208-V106	15	0.63								
	VVF53.15-0.8	S55208-V107	15	0.8								
	VVF53.15-1	S55208-V108	15	1								
	VVF53.15-1.25	S55208-V109	15	1.25								
	VVF53.15-1.6	S55208-V110	15	1.6								
	VVF53.15-2	S55208-V111	15	2								
	VVF53.15-2.5	S55208-V112	15	2.5								
	VVF53.15-3.2	S55208-V113	15	3.2								
	VVF53.15-4	S55208-V114	15	4								
	VVF53.20-6.3	S55208-V116	20	6.3	> 100	1600	750	2100	1100	2000	-	-
	VVF53.25-5	S55208-V117	25	5								
	VVF53.25-6.3	S55208-V118	25	6.3								
	VVF53.25-8	S55208-V119	25	8								
	VVF53.25-10	S55208-V120	25	10								
	VVF53.32-16	S55208-V122	32	16								
	VVF53.40-12.5	S55208-V123	40	12.5								
	VVF53.40-16	S55208-V124	40	16								
VVF53.40-20	S55208-V125	40	20									
VVF53.40-25	S55208-V126	40	25									
VVF53.50-31.5	S55208-V127	50	31.5	> 100	350	300	450	400	1200	1150	-	-
VVF53.50-40	S55208-V128	50	40									
VVF53.65-63 ³⁾	S55208-V129	65	63									
VVF53.80-100 ³⁾	S55208-V130	80	100									
VVF53.100-160 ³⁾	S55208-V131	100	160									
VVF53.125-250 ³⁾	S55208-V132	125	250									
VVF53.150-400	S55208-V133	150	400									
VVF53.50-40K ³⁾	S55208-V134	50	40									
VVF53.65-63K ³⁾	S55208-V135	65	63									
VVF53.80-100K ³⁾	S55208-V136	80	100									
VVF53.100-150K ³⁾	S55208-V158	100	150									
VVF53.125-220K ³⁾	S55208-V159	125	220									
VVF53.150-315K	S55208-V160	150	315									

¹⁾ DN 15...50: Flange dimensions for PN 16 and PN 25

DN 65...150: Flange dimensions only for PN 25

²⁾ Usable up to a max. medium temperature of 150 °C

³⁾ Valve characteristic for k_{vs} value 63 m³/h from 90 % stroke, k_{vs} value 100, 160 and 250 m³/h from 80 % stroke is optimized for maximum volumetric flow

VVF53..K: Valve characteristic for k_{vs} value 63 m³/h from 90 % stroke, k_{vs} value 40, 100, 150 and 220 m³/h from 80 % stroke is optimized for maximum volumetric flow

⁴⁾ Usable up to a max. medium temperature of 130 °C

DN = Nominal size

k_{vs} = Flow nominal value of cold water (5...30 °C) through the fully opened valve (H₁₀₀) at a differential pressure of 100 kPa (1 bar)

S_v = Rangeability

Δp_s = Maximum permissible differential pressure at which the motorized valve still closes securely against the pressure

Δp_{max} = Maximum permissible differential pressure across the valve's throughport for the entire positioning range of the motorized valve

Valves	Actuators					SAX.. ⁶⁾		SKD.. ²⁾		SKB..		SKC..		
	Stroke					20 mm		20 mm				40 mm		
	Positioning force					800 N		1000 N		2800 N		2800 N		
PN 25 PN 16 ¹⁾	Data sheet					N4501		N4561		N4664		N4566		
	Stock no.	DN	k _{vs} [m ³ /h]	S _v	[kPa]									
Steam ⁴⁾ Exclusive flow direction AB-A for steam. Also useful for maximum close-off pressure Δp _s and maximum differential pressure in operation (Δp _{max}) with fluids. Use with electro-hydraulic actuators only	VVF53.15-0.16	S55208-V100	15	0.16	> 50									
	VVF53.15-0.2	S55208-V101	15	0.2										
	VVF53.15-0.25	S55208-V102	15	0.25										
	VVF53.15-0.32	S55208-V103	15	0.32										
	VVF53.15-0.4	S55208-V104	15	0.4										
	VVF53.15-0.5	S55208-V105	15	0.5										
	VVF53.15-0.63	S55208-V106	15	0.63										
	VVF53.15-0.8	S55208-V107	15	0.8										
	VVF53.15-1	S55208-V108	15	1										
	VVF53.15-1.25	S55208-V109	15	1.25										
	VVF53.15-1.6	S55208-V110	15	1.6	> 100									
	VVF53.15-2	S55208-V111	15	2										
	VVF53.15-2.5	S55208-V112	15	2.5										
	VVF53.15-3.2	S55208-V113	15	3.2										
	VVF53.15-4 ⁵⁾	S55208-V114	15	3.6										
	VVF53.20-6.3 ⁵⁾	S55208-V116	20	5										
	VVF53.25-5	S55208-V117	25	5										
	VVF53.25-6.3	S55208-V118	25	6.3										
	VVF53.25-8	S55208-V119	25	8										
	VVF53.25-10 ⁵⁾	S55208-V120	25	8										
	VVF53.32-16 ⁵⁾	S55208-V122	32	15	> 100									
	VVF53.40-12.5	S55208-V123	40	12.5										
	VVF53.40-16	S55208-V124	40	16										
	VVF53.40-20	S55208-V125	40	20										
	VVF53.40-25 ⁵⁾	S55208-V126	40	23										
	VVF53.50-31.5	S55208-V127	50	31.5										
VVF53.50-40	S55208-V128	50	40											
VVF53.65-63	S55208-V129	65	63											
VVF53.80-100	S55208-V130	80	100											
VVF53.100-160 ⁵⁾	S55208-V131	100	150											
VVF53.125-250 ⁵⁾	S55208-V132	125	220	> 100										
VVF53.150-400 ⁵⁾	S55208-V133	150	360											

Valves	Actuators					Δp _{max} [kPa]											
	Stroke					A → AB		AB → A		A → AB		AB → A		A → AB		AB → A	
	Positioning force					A → AB		AB → A		A → AB		AB → A		A → AB		AB → A	
PN 25 PN 16 ¹⁾	Data sheet					N4501		N4561		N4664		N4566		N4566			
	Stock no.	DN	k _{vs} [m ³ /h]	S _v	[kPa]												
Fluids	VXF53.15-1.6	S55208-V140	15	1.6	> 100	1200	200	1200	200	1200	200						
	VXF53.15-2.5	S55208-V141	15	2.5													
	VXF53.15-4	S55208-V142	15	4													
	VXF53.20-6.3	S55208-V144	20	6.3													
	VXF53.25-6.3	S55208-V145	25	6.3													
	VXF53.25-10	S55208-V146	25	10													
	VXF53.32-16	S55208-V148	32	16													
	VXF53.40-16	S55208-V149	40	16													
	VXF53.40-25	S55208-V150	40	25													
	VXF53.50-40	S55208-V152	50	40													
	VXF53.65-63 ³⁾	S55208-V153	65	63													
	VXF53.80-100 ³⁾	S55208-V154	80	100													
	VXF53.100-160 ³⁾	S55208-V155	100	160													
	VXF53.125-250 ³⁾	S55208-V156	125	250													
VXF53.150-400	S55208-V157	150	400														

- 1) DN 15...50: Flange dimensions for PN 16 and PN 25
DN 65...150: Flange dimensions only for PN 25
- 2) Usable up to a max. medium temperature of 150 °C
- 3) Valve characteristic for k_{vs} value 63 m³/h from 90 % stroke, k_{vs} value 100, 160 and 250 m³/h from 80 % stroke is optimized for maximum volumetric flow
- 4) Operate with opposite flow direction with steam
- 5) Reduced k_{vs} value
- 6) Usable up to a max. medium temperature of 130 °C

Note

When using a stem heating element with a medium temperature of below $-5\text{ }^{\circ}\text{C}$, the stem sealing gland must be replaced. In this case, the sealing gland must be ordered separately (Stock number: 4 284 8806 0).

Ordering

Example

Product number	Stock number	Description
VXF53.25-6.3	S55208-V145	3-port valve with flange, PN 25
SAX31.03	S55150-A106	Electro-hydraulic actuator

Delivery

Valves, actuators and accessories are packed and delivered as separate items.

Note

Counter-flanges, bolts and gaskets must be provided on site.

Spare parts, Rev.-Nr.

See page 15

Equipment combinations

Product number	Description	Stroke	Positioning force	Operating voltage	Positioning signal	Spring return time	Positioning time	LED	Manual adjuster	Auxiliary functions		
SAX31.00	S55150-A105	20 mm	800 N	AC 230 V	3-position	-	120 s	-	Push and fix	1) 2) 3)		
SAX31.03	S55150-A106						30 s					
SAX61.03	S55150-A100			AC/DC 24 V	3-position	-	120 s	-	Push and fix	1)		
SAX61.03U	S55150-A100-A100						30 s					
SAX81.00	S55150-A102						30 s					
SAX81.03	S55150-A103			20 mm	1000 N	AC 230 V	3-position	-	Opening: 30 s Closing: 10 s	-	Turn, Position is maintained	1)
SAX81.03U	S55150-A103-A100	120 s										
SKD32.21	SKD32.21	20 mm	1000 N	AC 230 V	3-position	-	8 s	-	Turn, Position is maintained	1)		
SKD32.50	SKD32.50						120 s					
SKD32.51	SKD32.51						8 s					
SKD60	SKD60			AC 24 V	3-position	-	15 s	-	Opening: 30 s Closing: 15 s	✓	Turn, Position is maintained	2) 4)
SKD62	SKD62						120 s					
SKD62U	SKD62U						8 s					
SKD62UA	SKD62UA			20 mm	2800 N	AC 230 V	3-position	-	120 s	-	Turn, Position is maintained	1)
SKD82.50	SKD82.50								10 s			
SKD82.50U	SKD82.50U	10 s										
SKD82.51	SKD82.51	AC 24 V	3-position			-	10 s	-	Opening: 120 s Closing: 10 s	✓	Turn, Position is maintained	2) 4)
SKD82.51U	SKD82.51U						120 s					
SKB32.50	SKB32.50						120 s					
SKB32.51	SKB32.51	40 mm	2800 N	AC 230 V	3-position	-	120 s	-	Turn, Position is maintained	1)		
SKB60	SKB60						18 s					
SKB62	SKB62						20 s					
SKB62U	SKB62U			AC 24 V	3-position	-	120 s	-	Opening: 120 s Closing: 20 s	✓	Turn, Position is maintained	2) 4)
SKB62UA	SKB62UA						120 s					
SKB82.50	SKB82.50						18 s					
SKB82.50U	SKB82.50U	AC 230 V	3-position	-	120 s	-	120 s	-	Turn, Position is maintained	1)		
SKB82.51	SKB82.51				18 s							
SKB82.51U	SKB82.51U				18 s							
SKC32.60	SKC32.60	40 mm	2800 N	AC 230 V	3-position	-	120 s	-	Turn, Position is maintained	1)		
SKC32.61	SKC32.61						18 s					
SKC60	SKC60						20 s					
SKC62	SKC62			AC 24 V	3-position	-	120 s	-	Opening: 120 s Closing: 20 s	✓	Turn, Position is maintained	2) 4)
SKC62U	SKC62U						120 s					
SKC62UA	SKC62UA						18 s					
SKC82.60	SKC82.60			AC 230 V	3-position	-	120 s	-	120 s	-	Turn, Position is maintained	1)
SKC82.60U	SKC82.60U						18 s					
SKC82.61	SKC82.61	18 s										
SKC82.61U	SKC82.61U											

- 1) Auxiliary switch, potentiometer
- 2) Position feedback, forced control, selection of valve characteristic
- 3) Optional: Sequence control, selection of acting direction
- 4) Plus sequence control, stroke limitation, and selection of acting direction





Product documentation

- Mounting Instructions M4030 74 319 0749 0
- Basic documentation P4030 Contains background information and technical basic knowledge of valves

Technical and mechanical design

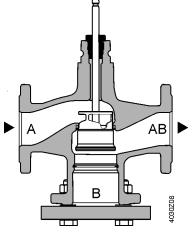
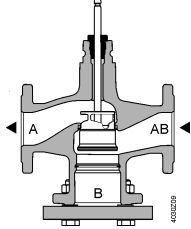

The illustrations below show the basic design of the valves. Constructional features, such as the shape of plugs, may differ.

2-port valves

 Fluids	 Steam (Fluids possible)
 Closing against the pressure	 Closing with the pressure
 <p>A → AB</p> <p>For use with all actuators</p>	 <p>A ← AB</p> <p>Use with electro-hydraulic actuators only</p>

2-port valves pressure compensated

The VVF53..K valves use a pressure-compensated plug. This enables the same type of actuators to be used for the control of volumetric flow at higher differential pressures.

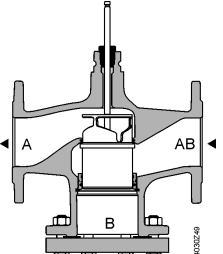
 Fluids and Steam
 Closing with the pressure
 <p>A ← AB</p> <p>Use with electro-hydraulic actuators only</p>



Note

2-port valves do not become 3-port valves by removing the blank flange!

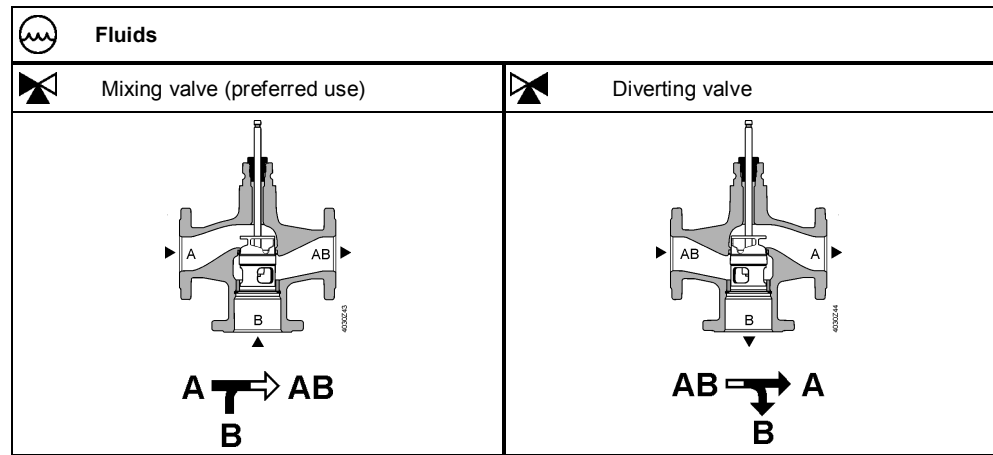
3-port valves



Accessories

Product number	Stock number	Description	Note	
ASZ6.6	S55845-Z108	Stem heating element	Required for medium temperatures < 0 °C	
-	428488060	Stem sealing gland	When using valves of the V..F53.. lines with a stem heating element and a medium temperature below -5 °C, the stem sealing gland must be replaced. With the gland 428488060 the valve can be used with water, water with antifreeze and brines between -20 °C and 150 °C.	

Adapter type	Stock number	Bolts included	Description	VXF41..	
ALF41B15	S55845-Z110	4x M12x90mm	Adapter for replacing 3-port valves VXF41.. by VXF53.. <ul style="list-style-type: none"> • Due to different dimensions of the bypass flange • Every valve to be replaced requires an adapter • Adapter is supplied with the required number and size of bolts and nuts as well as two suitable flat sealings Replace 3-port valves VXF41..., DN 65...150 by 3-port valves VXF43.. (data sheet N4404).	DN 15	
ALF41B25	S55845-Z111	4x M12x90mm		DN 25	
ALF41B40	S55845-Z112	4x M16x90mm		DN 40	
ALF41B50	S55845-Z113	4x M16x90mm		DN 50	

Sizing

Flow chart

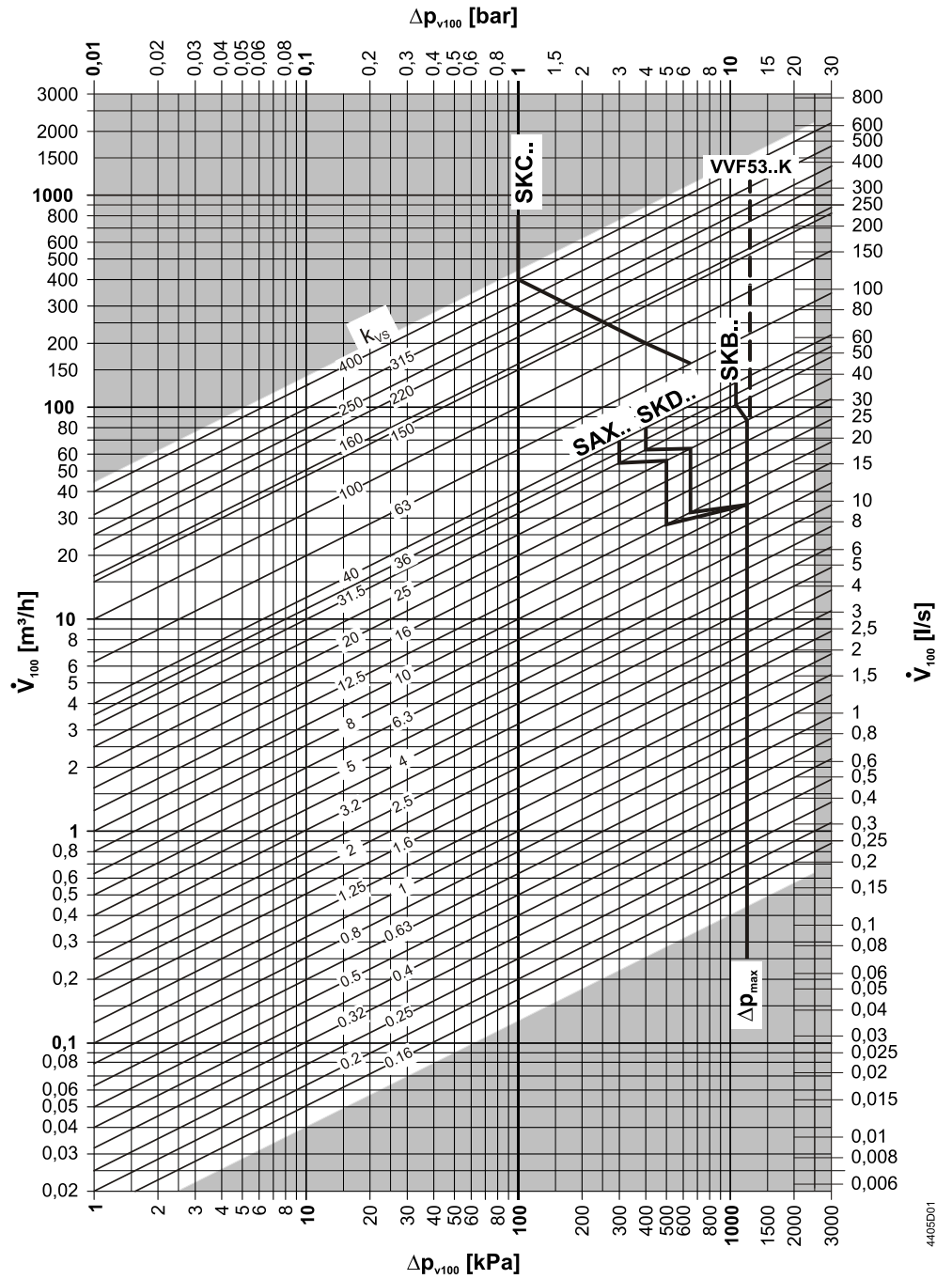

Δp_{max} values apply for the mixing function. Δp_{max} values for the diverting function see table "Type summary", page 2

Δp_{max} values for k_{vs} value 16, DN 32, see table "Type summary", page 2

4405D01

Valve characteristics
2-port valves

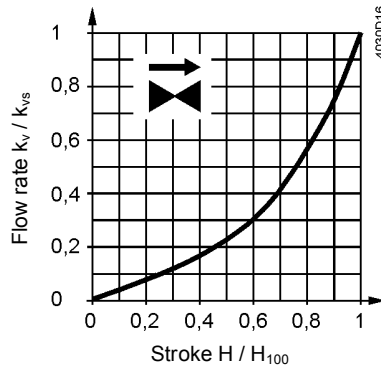

0...30 %: Linear
30...100 %: Equal percentage
 $n_{gl} = 3$ to VDI / VDE 2173
For high k_{vs} values the valve characteristic is optimized for maximum volumetric flow k_{V100} .

For product lines:
VVF53.125-200
VVF53.125-250
VVF53.125-220K
VVF53.150-315
VVF53.150-400
VVF53.150-315K

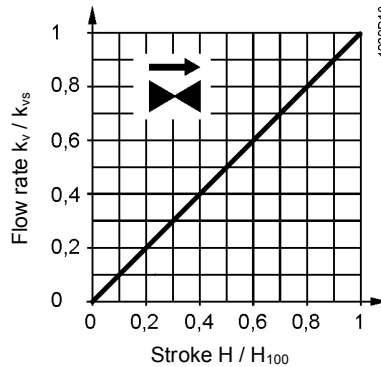

0...100 %: Linear

3-port valves

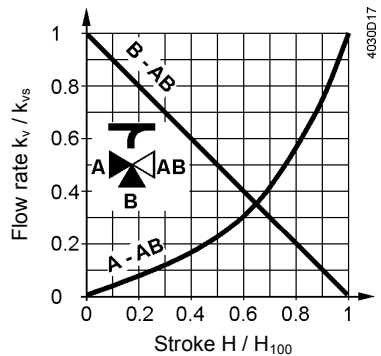

Throughport A-AB

0...30 %: Linear
30...100 %: Equal percentage
 $n_{gl} = 3$ to VDI / VDE 2173

For high k_{vs} values the valve characteristic is optimized for maximum volumetric flow k_{V100} .

Bypass B-AB

0...100 %: Linear
Port AB = constant volumetric flow
Port A = variable volumetric flow
Port B = Bypass (variable volumetric flow)

Mixing: Volumetric flow from port A and port B to port AB
Diverting: Volumetric flow from port AB to port A and port B

For product lines:
VXF53.125-250
VXF53.150-400

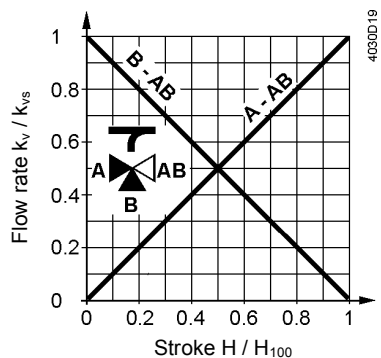

Throughport A-AB

0...100 %: Linear

Bypass B-AB

0...100 %: Linear

Operating pressure and medium temperature

Fluids
with V..F53..

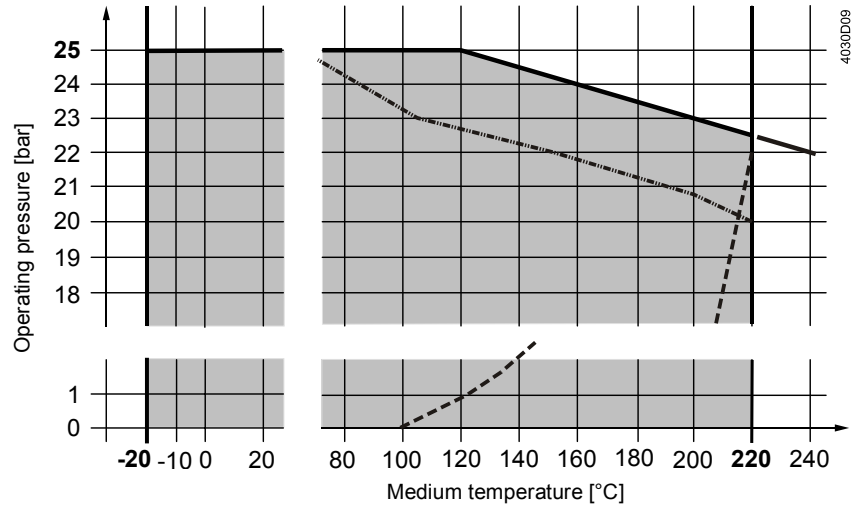

- Curve for saturated steam; steam forms below this line
- .. Operating pressure according to EN 1092, valid for 2-port valves with blank flange

Operating pressure and operating temperatures according to ISO 7005, EN 1092 and EN 12284

Notes

All relevant local directives must be observed

Saturated steam
Superheated steam
with VVF53..

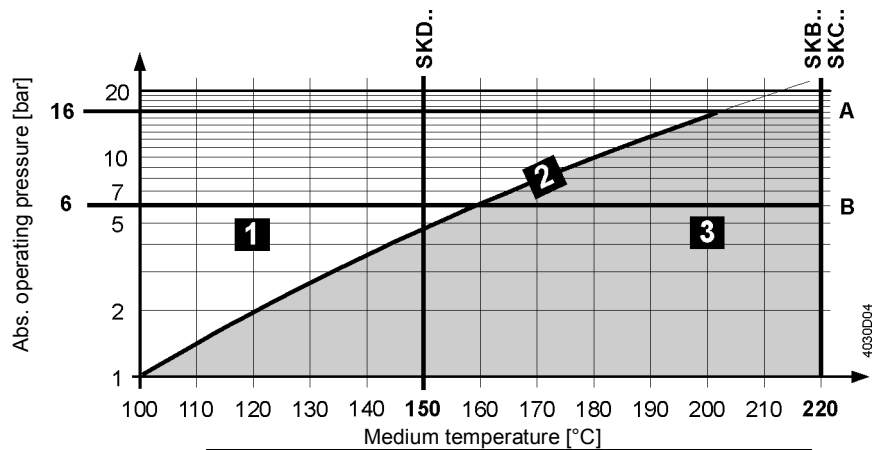

1	Water	-
2	Wet steam	To be avoided
3	Saturated steam Superheated steam	Permissible operating range
A	Subcritical pressure ratio	
B	Supercritical pressure ratio	

Medium compatibility and temperature ranges

Medium	Temperature range		Valve			Note
	T _{min} [°C]	T _{max} [°C]	VVF53..	VVF53..K	VXF53..	
Cold water	1	25	■	■	■	-
Low-temperature hot water	1	130	■	■	■	-
High-temperature hot water ¹⁾	130	150	■	■	■	-
	150	180	■	■	■	-
	180	220	■	■	■	-
Water with antifreeze	-5	150	■	■	■	V..F53: With a medium temperature of below -5 °C, the stem sealing gland must be replaced by the gland 428488060
	-10	150	■	- ⁴⁾	■	
	-20	150	■	- ⁴⁾	■	
Cooling water ²⁾	1	25	■	■	■	-
Brines	-5	150	■	■	■	V..F53: With a medium temperature of below -5 °C, the stem sealing gland must be replaced by the gland 428488060
	-10	150	■	- ⁴⁾	■	
	-20	150	■	- ⁴⁾	■	
Saturated steam ³⁾	100	150	■	■	-	-
	100	220	■	■	-	-
Superheated steam	120	150	■	■	-	-
	120	220	■	■	-	-
Heat transfer oils	20	220	■	■	■	On the basis of mineral oil
Super-clean water (demineralized and deionized)	1	150	-	-	-	

¹⁾ Differentiation due to saturated steam curve

²⁾ Open circuits

³⁾ Operate with inverted flow direction with steam

⁴⁾ VVF53..K can't be used with media below -5 °C due to the compensation sealing material

Fields of use

Fields of use		Valve	
		VVF53..	VXF53..
Generation	Boiler plants	■	■
	District heating plants	■	-
	Refrigeration plants	■	■
	Cooling towers ¹⁾	■	■
Distribution	Heating groups	■	■
	Air handling units	■	■

¹⁾ Open circuits

Engineering notes

Mounting location	Preferably mount the valves at the return, as the temperature is lower there and the strain on the stem sealing gland is lower. Operate valves of the product lines VVF53.. with inverted flow direction for steam.
Dirt trap	Mount a dirt filter or dirt trap before the valve to ensure proper functioning, and a long service life of the valve. Remove dirt, welding beads, etc. from the valves and pipes.
Cavitation	Cavitation can be avoided by limiting the pressure differential across the valve depending on the medium temperature and the prepressure.

Mounting notes

Mounting position

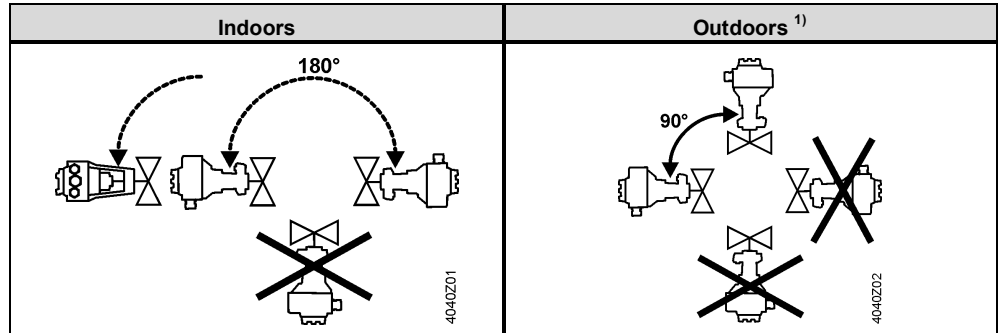

¹⁾ Only in combination with weather shield ASK39.1 and actuators SAX..

Mounting positions apply to both 2- and 3-port valves.

Commissioning notes



The valve may be put into operation only if actuator and valve are correctly assembled.

Note

Ensure that actuator stem and valve stem are rigidly connected in all positions.

Function check

Valve	Throughport A→AB	Bypass B→AB
Valve stem extends	Closes	Opens
Valve stem retracts	Opens	Closes

Maintenance notes

The valves are maintenance-free.



When servicing valves or actuators:

- Deactivate the pump and turn off the power supply
- Close the shutoff valves
- Fully reduce the pressure in the piping system and allow pipes to completely cool down

If necessary, disconnect the electrical wires.

Due to the different types of material used, the valve must be disassembled prior to disposal. Special handling of certain valve components may be required by law or may be sensible from an ecological point of view.

Local and currently valid legislation must be observed.

Disposal



Warranty

Application-related technical data are guaranteed only when the valves are used in connection with the Siemens actuators listed under "Equipment combinations", page 3.

When used with actuators of other manufacture, any warranty by Siemens becomes void.

Technical Data

Functional data	PN class	PN 25	
	Connection	Flange	
	Operating pressure	See Section "Operating pressure and medium temperature" page 9	
	Valve characteristics ¹⁾	See section "Valve characteristics", page 8	
	Leakage rate	Throughport	0...0.01 % of k_{vs} value (Class IV)
		Bypass	0.5...2 % of k_{vs} value with SKD.., SKB.., SKC.. 0.05 % of k_{vs} value with SAX..
	Permissible media	See table "Medium compatibility and temperature ranges", page 10	
	Medium temperature		-20...220 °C ²⁾
			VVF53..K: 1...220 °C
	Rangeability		DN 15, $k_{vs} \leq 1.25 \text{ m}^3/\text{h}$: >50
		DN 15...150: >100	
Nominal stroke		Up to DN 50: 20 mm From DN 65: 40 mm	
Materials	Valve body	EN-GJS-400-18-LT	
	Blank flange	VVF.. P265GH	
	Valve stem, seat, plug	Stainless steel	
	Stem sealing gland		Stainless steel
			FEPM (silicone-free)
	Compensation sealing		Stainless steel
			FEPM (silicone-free)
Adapter ALF41B..	Steel S235JRG2		
Standards	Pressure Equipment Directive	PED 97/23/EC	
	Pressure-carrying accessories	According to article 1, section 2.1.4	
	Fluid group 2	PN 25	
	without CE certification according to article 3, section 3 (good engineering practice)	$\leq \text{DN } 40$	
	Category I, with CE certification	DN 50...100	
	Category II, with CE certification, notified body identification number 0036	DN 125...150	
	PN class	ISO 7268	
	Operating pressure	ISO 7005, DIN EN 12284	
	Flanges	ISO 7005	
	Length of flanged valves	DIN EN 558-1, line 1	
	Valve characteristic	VDI 2173	
	Leakage rate	Throughport, Bypass according to EN 60534-4 / EN 1349	
	Water treatment	VDI 2035	

Environmental conditions		
Storage: IEC 60721-3-1	Class	1K3
	Temperature	-15...55 °C
	Rel. humidity	5...95 % r.h.
Transport: IEC 60721-3-2	Class	2K3, 2M2
	Temperature	-30...65 °C
	Rel. humidity	< 95 % r.H.
Operation: IEC 60721-3-3	Class	3K5, 3Z11
	Temperature	-15...55 °C
	Rel. humidity	5...95 % r.h.

Environmental compatibility

ISO 14001 (environment)
ISO 9001 (quality)
SN 36350 (environmentally compatible products)
RL 2002/95/EG (RoHS)

Dimensions / Weight	Dimensions	Weight
	See „Dimensions“, page 14	See „Dimensions“, page 14

- ¹⁾ For certain valve lines and high k_{vs} values, the valve characteristic is optimized for maximum volumetric flow k_{V100}
- ²⁾ For medium temperatures < -5 °C, the stem sealing gland must be replaced. The sealing gland must be ordered separately (Stock number: 4 284 8806 0).

Dimensions

VVF53..

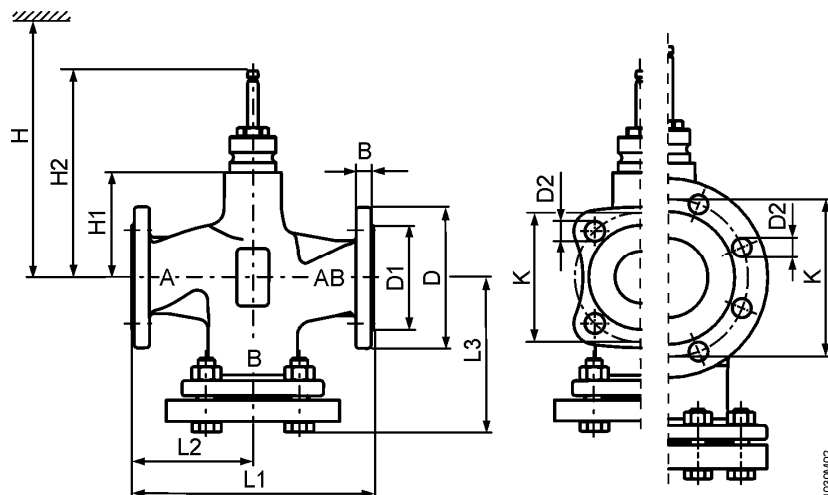

Product number	DN	kg	B	Ø D	Ø D1	Ø D2	L1	L2	L3	Ø K	H1	H2	H			
													SAX..	SKD..	SKB..	SKC..
VVF53..	15	4.2	14	95	46	14 (4x)	130	65	87.5	65	63	159.5	505	563	638	-
	20	5.3	16	105	56	14 (4x)	150	75	99.5	75	63	144.4	505	563	638	-
	25	6.1	15	115	65	14 (4x)	160	80	104.5	85	63	159.5	505	563	638	-
	32	8.7	17	140	76	19 (4x)	180	90	119	100	60	156.5	502	560	635	-
	40	10.1	16	150	84	19 (4x)	200	100	129	110	60	156.5	502	560	635	-
	50	13.5	16	165	99	19 (4x)	230	115	146	125	100	196.5	542	600	675	-
	65	22.2	17	185	118	19 (8x)	290	145	178	145	115	231.5	-	-	-	690
	80	27.7	17	200	132	19 (8x)	310	155	190	160	115	231.5	-	-	-	690
	100	38.6	17	235	156	23 (8x)	350	175	212.5	190	146	262.5	-	-	-	721
	125	54.4	17	270	184	28 (8x)	400	200	242	220	159	275.5	-	-	-	734
150	74.3	17	297	211	28 (8x)	480	240	284	250	186.5	303	-	-	-	762	
VVF53..K	50	13.6	16	165	99	19 (4x)	230	115	146	125	100	196.5	542	600	675	-
	65	22.3	17	185	118	19 (8x)	290	145	178	145	115	231.5	-	-	-	690
	80	27.9	17	200	132	19 (8x)	310	155	190	160	115	231.5	-	-	-	690
	100	39.0	17	235	156	23 (8x)	350	175	212.5	190	146	262.5	-	-	-	721
	125	57.5	17	270	184	28 (8x)	400	200	242	220	159	275.5	-	-	-	734
150	75.8	17	297	211	28 (8x)	480	240	284	250	186.5	303	-	-	-	762	

VXF53..

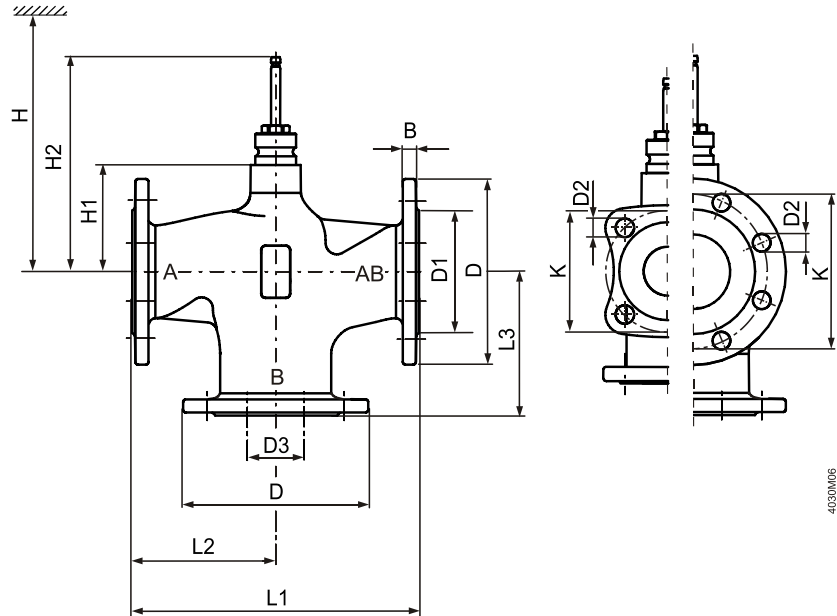

4030M06

Product number	DN	kg	B	Ø D	Ø D1	Ø D2	Ø D3	L1	L2	L3	Ø K	H1	H2	H			
														SAX..	SKD..	SKB..	SKC..
VXF53..	15	3.2	14	95	46	14 (4x)	25	130	65	65	65	63	159.5	505	563	638	-
	20	4.0	16	105	56	14 (4x)	35	150	75	75	75	63	159.5	505	563	638	-
	25	4.6	15	115	65	14 (4x)	38	160	80	80	85	63	159.5	505	563	638	-
	32	6.1	17	140	76	19 (4x)	46	180	90	90	100	60	156.5	502	560	635	-
	40	7.2	16	150	84	19 (4x)	57	200	100	100	110	60	156.5	502	560	635	-
	50	9.7	16	165	99	19 (4x)	69	230	115	115	125	100	196.5	542	600	675	-
	65	16.6	17	185	118	19 (8x)	86	290	145	145	145	115	231.5	-	-	-	690
	80	20.9	17	200	132	19 (8x)	100	310	155	155	160	115	231.5	-	-	-	690
	100	28.5	17	235	156	23 (8x)	123	350	175	175	190	146	262.5	-	-	-	721
	125	42.2	17	270	184	28 (8x)	149	400	200	200	220	159	275.5	-	-	-	734
	150	55.9	17	297	211	28 (8x)	174	480	240	240	250	186.5	303	-	-	-	762

Spare parts

Stem sealing gland

Product number	DN	Stock number	Comments	
VVF53.. VXF53..	DN 15...150	74 284 0061 0	Standard version with FEPM-O-ring for medium temperatures between -5 °C and 220 °C.	
		4 284 8806 0	When operating with medium temperatures below -5 °C . With the gland 428488060 the valve can be used with water, water with antifreeze and brines between -20 °C and 150 °C.	

Revision numbers

Product number	Valid from rev. no.	Product number	Valid from rev. no.	Product number	Valid from rev. no.
VVF53.15-0.16	..A	VVF53.50-40K	..B	VXF53.15-1.6	..A
VVF53.15-0.2	..A	VVF53.65-63K	..B	VXF53.15-2.5	..A
VVF53.15-0.25	..A	VVF53.80-100K	..B	VXF53.15-4	..A
VVF53.15-0.32	..A	VVF53.100-150K	..B	VXF53.20-6.3	..A
VVF53.15-0.4	..A	VVF53.125-220K	..B	VXF53.25-6.3	..A
VVF53.15-0.5	..A	VVF53.150-315K	..B	VXF53.25-10	..A
VVF53.15-0.63	..A			VXF53.32-16	..A
VVF53.15-0.8	..A			VXF53.40-16	..A
VVF53.15-1	..A			VXF53.40-25	..A
VVF53.15-1.25	..A			VXF53.50-40	..A
VVF53.15-1.6	..A			VXF53.65-63	..A
VVF53.15-2	..A			VXF53.80-100	..A
VVF53.15-2.5	..A			VXF53.100-160	..A
VVF53.15-3.2	..A			VXF53.125-250	..A
VVF53.15-4	..A			VXF53.150-400	..A
VVF53.20-6.3	..A				
VVF53.25-5	..A				
VVF53.25-6.3	..A				
VVF53.25-8	..A				
VVF53.25-10	..A				
VVF53.32-16	..A				
VVF53.40-12.5	..A				
VVF53.40-16	..A				
VVF53.40-20	..A				
VVF53.40-25	..A				
VVF53.50-31.5	..A				
VVF53.50-40	..A				
VVF53.65-63	..C				
VVF53.80-100	..C				
VVF53.100-160	..C				
VVF53.125-250	..C				
VVF53.150-400	..C				