



VVF43..
VVF43..K



VXF43..

ACVATIX™

2- and 3-port valves with flanged connections, PN 16

VVF43..
VXF43..

From the large-stroke valve line

- High-performance valves for medium temperatures from -20...220 °C
- Valve body of nodular cast iron EN-GJS-400-18-LT
- DN 65...150
- k_{vs} 50...400 m³/h
- Flange type 21, flange design B
- VVF43..K with pressure compensation to handle high differential pressure
- Equipable with electro-hydraulic actuators SKC..



Use

In boiler, district heating and refrigeration plants, cooling towers, heating groups, and in air handling units as control or shutoff valves.

For use in closed or open hydraulic circuits (observe cavitation).

Type summary

	Valves PN 16 	Actuators				SKC..	
		Stroke				40 mm	
		Positioning force				2800 N	
		Data sheet				N4566	
		Stock number	DN	k_{vs} [m ³ /h]	S_v	Δp_s	Δp_{max}
						[kPa]	
Fluids Preferred flow direction A-AB with fluids for low noise operation and high k_{vs} -values with all actuator types	VVF43.65-50	S55206-V100	65	50	> 100	700	650
	VVF43.65-63 ¹⁾	S55206-V101	65	63		450	400
	VVF43.80-80	S55206-V102	80	80		300	250
	VVF43.80-100 ¹⁾	S55206-V103	80	100		175	160
	VVF43.100-125	S55206-V104	100	125		125	100
	VVF43.100-160 ¹⁾	S55206-V105	100	160			
	VVF43.125-200 ¹⁾	S55206-V106	125	200			
	VVF43.125-250 ¹⁾	S55206-V107	125	250			
	VVF43.150-315 ¹⁾	S55206-V108	150	315			
	VVF43.150-400	S55206-V109	150	400			
Steam ²⁾ Exclusive flow direction AB-A for steam. Also useful for maximum close-off pressure Δp_s and maximum differential pressure in operation (Δp_{max}) with fluids. Use with electro-hydraulic actuators only	VVF43.65-50	S55206-V100	65	50	> 100	1600	800
	VVF43.65-63	S55206-V101	65	63			750
	VVF43.80-80	S55206-V102	80	80			500
	VVF43.80-100	S55206-V103	80	100			300
	VVF43.100-125	S55206-V104	100	125			200
	VVF43.100-160 ³⁾	S55206-V105	100	150 ³⁾			800
	VVF43.125-200	S55206-V106	125	200			200
	VVF43.125-250 ³⁾	S55206-V107	125	220 ³⁾			
	VVF43.150-315 ³⁾	S55206-V108	150	280 ³⁾			
	VVF43.150-400 ³⁾	S55206-V109	150	360 ³⁾			
Fluids and Steam Compensated valves above DN65 are optimized for a single flow direction AB-A for fluids and steam.	VVF43.65-63K	S55206-V110	65	63	> 100	1600	800
	VVF43.80-100K	S55206-V111	80	100			
	VVF43.100-150K	S55206-V120	100	150			
	VVF43.125-220	S55206-V121	125	220			
	VVF43.150-315K	S55206-V122	150	315			

		Stock number	DN	k_{vs} [m ³ /h]	S_v	Δp_{max} [kPa]	
							
Fluids	VXF43.65-63 ¹⁾	S55206-V115	65	63	> 100	650	200
	VXF43.80-100 ¹⁾	S55206-V116	80	100		400	
	VXF43.100-160 ¹⁾	S55206-V117	100	160		250	150
	VXF43.125-250 ¹⁾	S55206-V118	125	250		160	100
	VXF43.150-400	S55206-V119	150	400		100	70

- ¹⁾ Valve characteristic for k_{vs} value 63 m³/h from 90 % stroke, k_{vs} value 100, 160, 200 and 250 m³/h from 80 % stroke and k_{vs} value 315 m³/h from 70 % stroke is optimized for maximum volumetric flow
- ²⁾ Operate with opposite flow direction with steam
- ³⁾ Reduced k_{vs} value

DN = Nominal size

k_{vs} = Flow nominal value of cold water (5...30 °C) through the fully opened valve (H_{100}) at a differential pressure of 100 kPa (1 bar)

S_v = Rangeability

Δp_s = Maximum permissible differential pressure at which the motorized valve still closes securely against the pressure

Δp_{max} = Maximum permissible differential pressure across the valve's throughport for the entire positioning range of the motorized valve

Note

When using a stem heating element with a medium temperature of below -5 °C, the stem sealing gland must be replaced. In this case, the stem sealing gland must be ordered separately (Stock number: 4 284 8806 0).

Ordering

Example

Product number	Stock number	Description
VXF43.65-63	S55206-V115	3-port valve with flange, PN 16
SKC32.60	SKC32.60	Electro-hydraulic actuator

Delivery

Valves, actuators and accessories are packed and delivered as separate items.

Note

Counter-flanges, bolts and gaskets must be provided on site.

Spare parts, Rev.-Nr.

See page 12

Equipment combinations

Product number	Description	Stroke	Positioning force	Operating voltage	Positioning signal	Spring return time	Positioning time	LED	Manual adjuster	Auxiliary functions	
SKC32.60	SKC32.60	40 mm	2800 N	AC 230 V	3-position	-	120 s	-	Turn, Position is maintained	1)	
SKC32.61	SKC32.61					18 s					
SKC60	SKC60			AC 24 V	0...10 V 4...20 mA 0...1000 Ω	-	Opening: 120 s Closing: 20 s	✓		2)	
SKC62	SKC62					20 s					
SKC62U	SKC62U										
SKC62UA	SKC62UA					3-position	-	120 s		-	3)
SKC82.60	SKC82.60						18 s				
SKC82.60U	SKC82.60U										
SKC82.61	SKC82.61	1)									
SKC82.61U	SKC82.61U										

1) Auxiliary switch, potentiometer

2) Position feedback, forced control, selection of valve characteristic

3) Plus sequence control, stroke limitation, and selection of acting direction





Product documentation

- Mounting Instructions M4030 74 319 0749 0
- Basic documentation P4030 Contains background information and technical basic knowledge of valves

Technical and mechanical design

The illustrations below show the basic design of the valves. Constructional features, such as the shape of plugs, may differ.

2-port valves

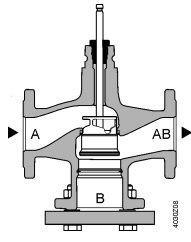
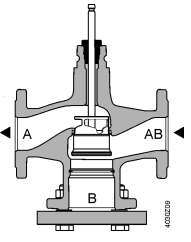
 Fluids	 Steam (Fluids possible)
 Closing against the pressure	 Closing with the pressure
 <p>A → AB</p> <p>For use with all actuators</p>	 <p>A ← AB</p> <p>Use with electro-hydraulic actuators only</p>

**2-port valves
pressure compensated**

The VVF43..K valves use a pressure-compensated plug. This enables the same type of actuators to be used for the control of volumetric flow at higher differential pressures.

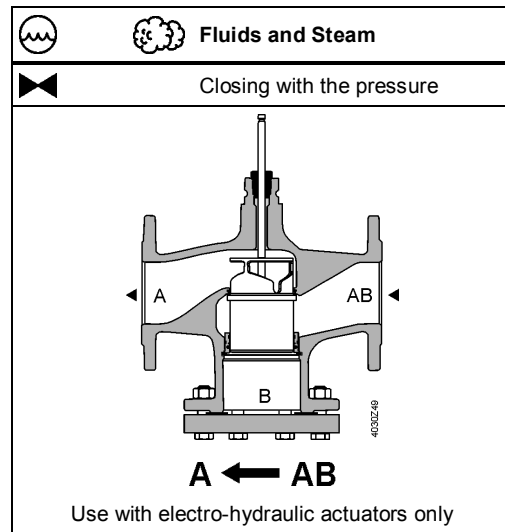

Note

2-port valves do not become 3-port valves by removing the blank flange!

3-port valves

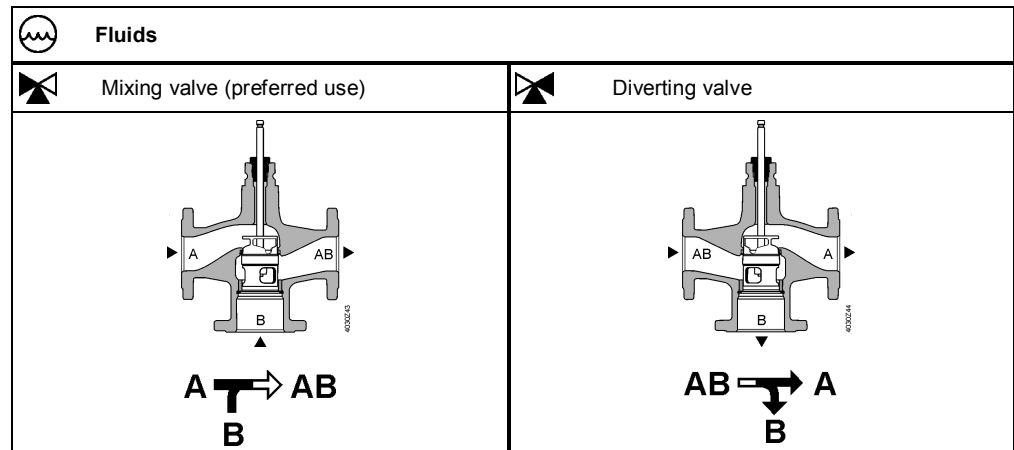

Accessories

Product number	Stock number	Description	Note	Example
ASZ6.6	S55845-Z108	Stem heating element	Required for medium temperatures < 0 °C	
-	428488060	Stem sealing gland	When using valves of the V..F43.. lines with a stem heating element and a medium temperature below -5 °C, the stem sealing gland must be replaced. With the gland 428488060 the valve can be used with water, water with antifreeze and brines between -20 °C and + 150 °C.	

Adapter type	Stock number	Bolts included	Description	VXF41..	Example
ALF41B65	S55845-Z114	4x M16x90mm	Adapter for replacing 3-port valves VXF41.. by VXF43.. • Due to different dimensions of the bypass flange • Every valve to be replaced requires an adapter • Adapter is supplied with the required number and size of bolts and nuts as well as two suitable flat sealings Replace 3-port valves VXF41... DN 15...50 by 3-port valves VXF53.. (data sheet N4405).	DN 65	
ALF41B80	S55845-Z115	8x M16x110mm		DN 80	
ALF41B100	S55845-Z116	8x M16x110mm		DN 100	
ALF41B125	S55845-Z117	8x M16x110mm		DN 125	
ALF41B150	S55845-Z118	8x M20x110mm		DN 150	

Sizing

Flow chart

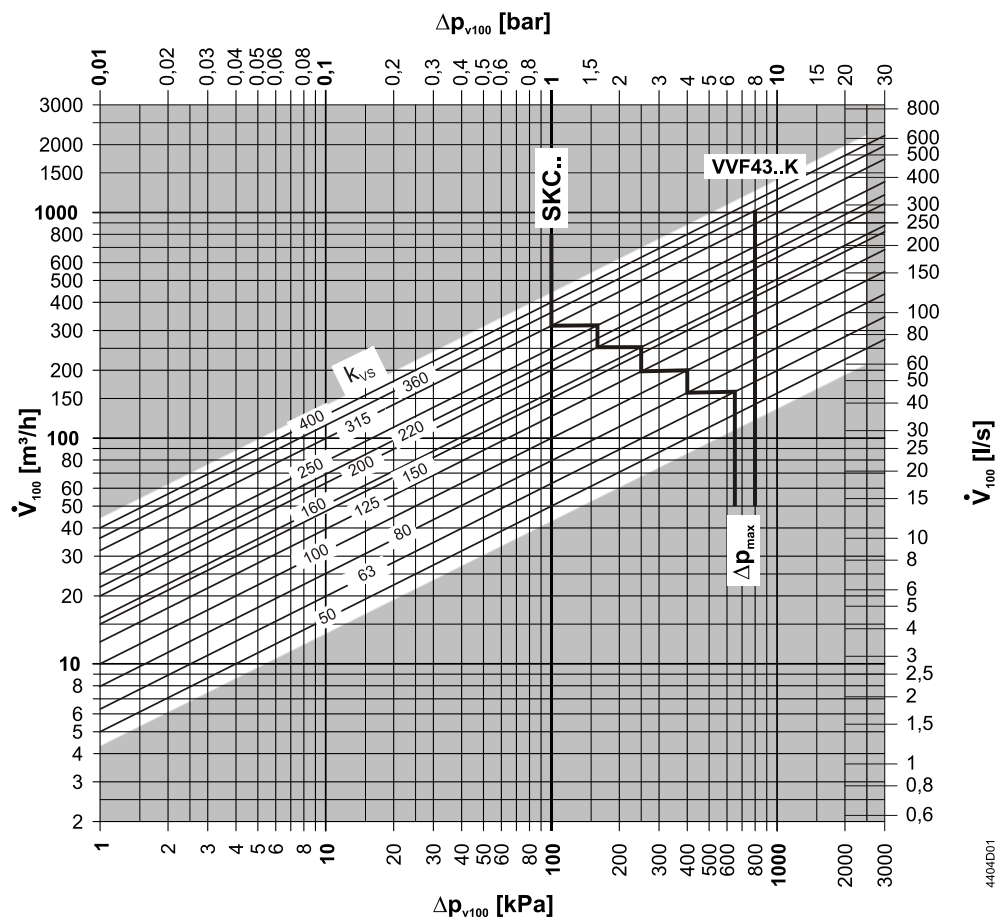

Δp_{max} values apply for the mixing function. Δp_{max} values for the diverting function see table „Type summary“, page 2

4404D01

Valve characteristics 2-port valves

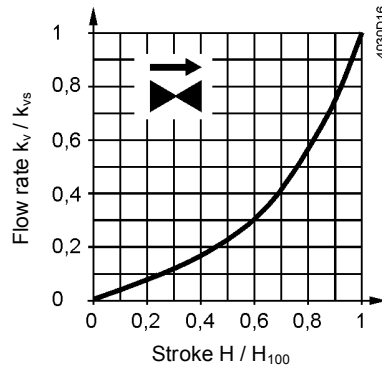

0...30 %: Linear
30...100 %: Equal percentage
 $n_{gl} = 3$ to VDI / VDE 2173

For high k_{vs} values the valve characteristic is optimized for maximum volumetric flow k_{V100} .

For product lines:

VVF43.125-200
VVF43.125-250
VVF43.125-220K
VVF43.150-315
VVF43.150-400
VVF43.150-315K

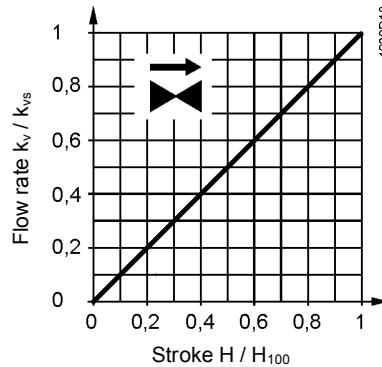

0...100 %: Linear

3-port valves

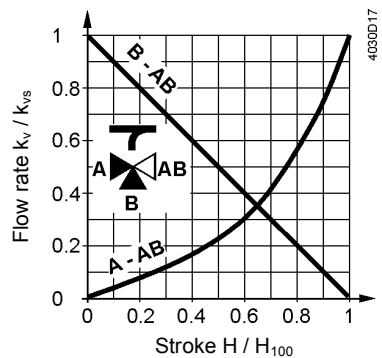

Throughport A-AB

0...30 %: Linear
30...100 %: Equal percentage
 $n_{gl} = 3$ to VDI / VDE 2173

For high k_{vs} values the valve characteristic is optimized for maximum volumetric flow k_{V100} .

Bypass B-AB

0...100 %: Linear
Port AB = constant flow
Port A = variable flow
Port B = bypass (variable flow)

Mixing: Flow from port A and port B to port AB
Diverting: Flow from port AB to port A and port B

For product lines:

VXF43.125-250
VXF43.150-400

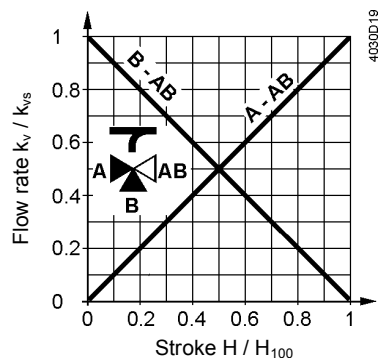

Throughport A-AB

0...100 %: Linear

Bypass B-AB

0...100 %: Linear

Operating pressure and medium temperature

Fluids
with V..F43..

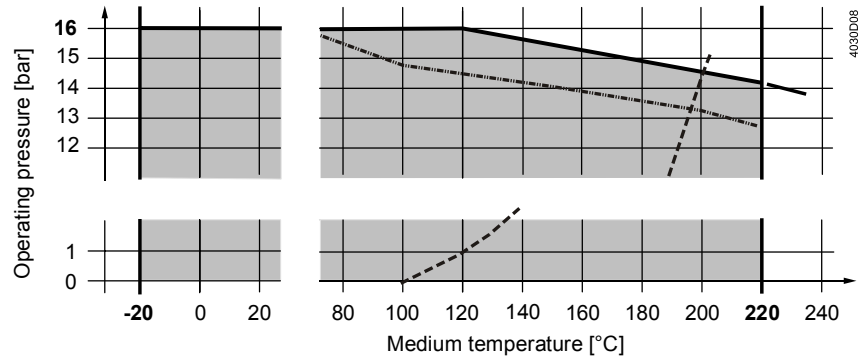

- Curve for saturated steam; steam forms below this line
- .. Operating pressure according to EN 1092, valid for 2-port valves with blank flange

Operating pressure and operating temperatures according to ISO 7005, EN 1092 and EN 12284

Notes

All relevant local directives must be observed

Saturated steam
Superheated steam
with VVF43..

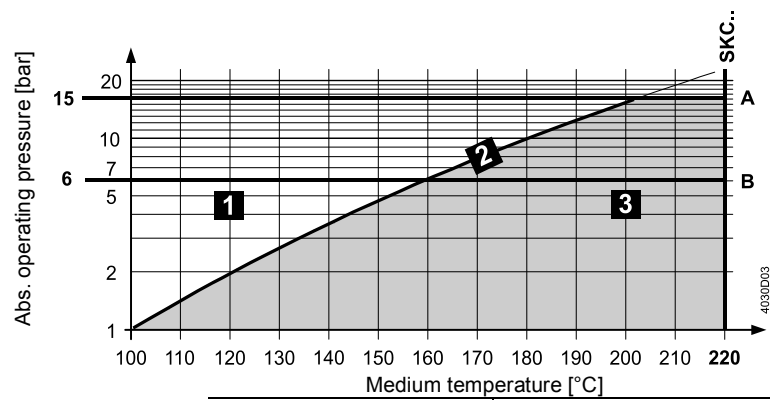

1	Water	-
2	Wet steam	To be avoided
3	Saturated steam Superheated steam	Permissible operating range
A	Subcritical pressure ratio	
B	Supercritical pressure ratio	

Medium compatibility and temperature ranges

Medium	Temperature range		Valve			Note
	T _{min} [°C]	T _{max} [°C]	VVF43..	VVF43..K	VXF43..	
Cold water	1	25	■	■	■	-
Low-temperature hot water	1	130	■	■	■	-
High-temperature hot water ¹⁾	130	150	■	■	■	-
	150	180	■	■	■	-
Water with antifreeze	-5	150	■	■	■	V..F43: With a medium temperature of below -5 °C, the stem sealing gland must be replaced by the gland 428488060.
	-10	150	■	- ⁴⁾	■	
	-20	150	■	- ⁴⁾	■	
Cooling water ²⁾	1	25	■	■	■	-
Brines	-5	150	■	■	■	V..F43: With a medium temperature of below -5 °C, the stem sealing gland must be replaced by the gland 428488060.
	-10	150	■	- ⁴⁾	■	
	-20	150	■	- ⁴⁾	■	
Saturated steam ³⁾	100	150	■	■	-	-
	150	200	■	■	-	-
Superheated steam ³⁾	120	150	■	■	-	-
	150	220	■	■	-	-
Heat transfer oils	20	220	■	■	■	On the basis of mineral oil
Super-clean water (demineralized and deionized water)	1	150	-	-	-	

¹⁾ Differentiation due to saturated steam curve

²⁾ Open circuits

³⁾ Operate with inverted flow direction with steam

⁴⁾ VVF43..K can't be used with media below -5 °C due to the compensation sealing material

Fields of use

Fields of use		valves	
		VVF43..	VXF43..
Generation	Boiler plants	■	■
	District heating plants	■	-
	Refrigeration plants	■	■
	Cooling towers ¹⁾	■	■
Distribution	Heating groups	■	■
	Air handling units	■	■

¹⁾ Open circuits

Engineering notes

Mounting location

Preferably mount the valves at the return, as the temperature is lower there and the strain on the stem sealing gland is lower.

Dirt trap

Operate valves of the product lines VVF43.. with inverted flow direction for steam. Mount a dirt filter or dirt trap before the valve to ensure proper functioning, and a long service life of the valve. Remove dirt, welding beads, etc. from the valves and pipes.

Cavitation

Cavitation can be avoided by limiting the pressure differential across the valve depending on the medium temperature and the prepressure.

Mounting notes

Mounting position

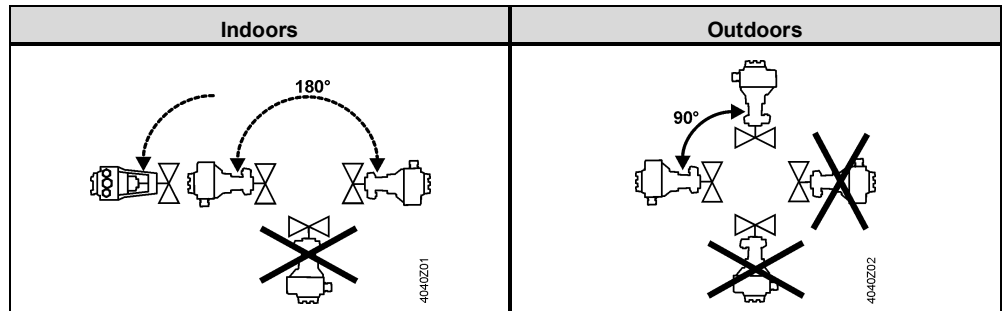

Mounting positions apply to both 2- and 3-port valves.

Commissioning notes



The valve may be put into operation only if actuator and valve are correctly assembled.

Note

Ensure that actuator stem and valve stem are rigidly connected in all positions.

Function check

Valve	Throughport A→AB	Bypass B→AB
Valve stem extends	Closes	Opens
Valve stem retracts	Opens	Closes

Maintenance notes

The valves are maintenance-free.



When servicing valves or actuators:

- Deactivate the pump and turn off the power supply
- Close the shutoff valves
- Fully reduce the pressure in the piping system and allow pipes to completely cool down

If necessary, disconnect the electrical wires.

Due to the different types of material used, the valve must be disassembled prior to disposal. Special handling of certain valve components may be required by law or may be sensible from an ecological point of view.

Local and currently valid legislation must be observed.

Disposal



Warranty

Application-related technical data are guaranteed only when the valves are used in connection with the Siemens actuators listed under "Equipment combinations", page 3.

When used with actuators of other manufacture, any warranty by Siemens becomes void.

Technical Data

Functional data	PN class	PN 16	
	Connection	Flange	
	Operating pressure	See Section "Operating pressure and medium temperature", page 7	
	Valve characteristics ¹⁾	See section "Valve characteristics", page 6	
	Leakage rate	Throughport	0...0.01 % of k_{vs} value (Class IV)
		Bypass	0.5...2 % of k_{vs} value
	Permissible media	See table "Medium compatibility and temperature ranges", page 8	
	Medium temperature		-20...220 °C ²⁾
			VVF43..K: 1...220 °C
	Rangeability	>100	
	Nominal stroke	40 mm	
Materials	Valve body	EN-GJS-400-18-LT	
	Blank flange	P265GH	
	Valve stem, seat, plug	Stainless steel	
	Stem sealing gland	Stainless steel	
		FEPM (silicone-free)	
	Compensation sealing	Stainless steel	
FEPM (silicone-free)			
	Adapter ALF41B..	Steel S235JRG2	
Standards	Pressure Equipment Directive	PED 97/23/EC	
	Pressure-carrying accessories	According to article 1, section 2.1.4	
	Fluid group 2	PN 16	
	Category I, with CE certification	DN 65...125	
	Category II, with CE certification, notified body identification number 0036	DN 150	
	PN class	ISO 7268	
	Operating pressure	ISO 7005, DIN EN 12284	
	Flanges	ISO 7005	
	Length of flanged valves	DIN EN 558-1, line 1	
	Valve characteristic	VDI 2173	
	Leakage rate	Throughport, bypass according to EN 60534-4 / EN 1349	
	Water treatment	VDI 2035	

Environmental conditions

Storage: IEC 60721-3-1	Class	1K3
	Temperature	-15...55 °C
	Rel. humidity	5...95 % r.h.
Transport: IEC 60721-3-2	Class	2K3, 2M2
	Temperature	-30...65 °C
	Rel. humidity	< 95 % r.h.
Operation: IEC 60721-3-3	Class	3K5, 3Z11
	Temperature	-15...55 °C
	Rel. humidity	5...95 % r.h.

Environmental compatibility	ISO 14001 (environment)
	ISO 9001 (quality)
	SN 36350 (environmentally compatible products)
	RL 2002/95/EG (RoHS)

Dimensions / Weight	Dimensions	See „Dimensions“, page 11
	Weight	See „Dimensions“, page 11

- 1) For certain valve lines and high k_{vs} values, the valve characteristic is optimized for maximum volumetric flow k_{V100}
- 2) For medium temperatures < -5 °C, the stem sealing gland must be replaced. The sealing gland must be ordered separately (Stock number: 4 284 8806 0).

Dimensions

VVF43..

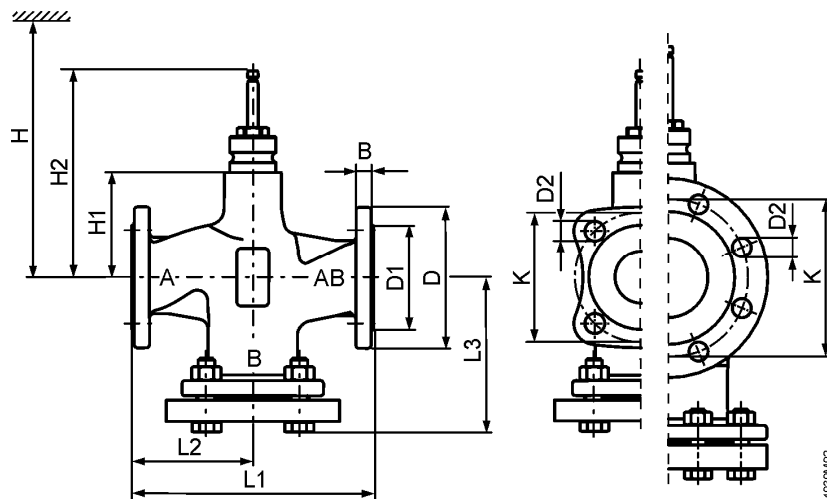

Product number	DN	kg	B	Ø D	Ø D1	Ø D2	L1	L2	L3	Ø K	H1	H2	H SKC..
VVF43..	65	21.8	17	185	118	19 (4x)	290	145	178	145	115	231.5	690
	80	27.7	17	200	132	19 (8x)	310	155	190	160	115	231.5	690
	100	33.6	17	220	156	19 (8x)	350	175	206	180	146	262.5	721
	125	50	17	250	184	19 (8x)	400	200	233	210	159	275.5	734
	150	66.3	17	284	211	23 (8x)	480	240	275.5	240	186.5	303	762
VVF43..K	65	21.9	17	185	118	19 (4x)	290	145	178	145	115	231.5	690
	80	27.9	17	200	132	19 (8x)	310	155	190	160	115	231.5	690
	100	34	17	220	156	19 (8x)	350	175	206	180	146	262.5	721
	125	46.9	17	250	184	19 (8x)	400	200	233	210	159	275.5	734
	150	67.7	17	284	211	23 (8x)	480	240	275.5	240	186.5	303	762

VXF43..

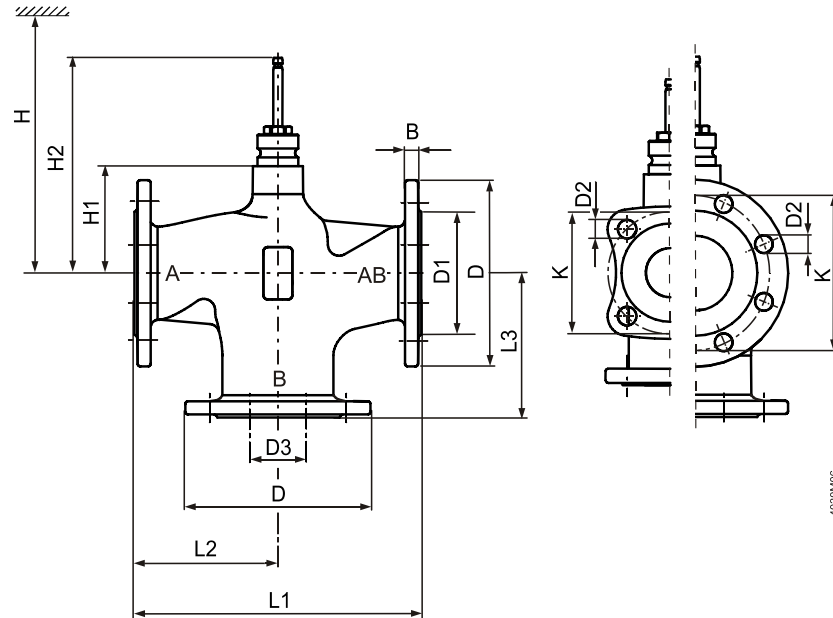

4030/006

Product number	DN	kg	B	Ø D	Ø D1	Ø D2	Ø D3	L1	L2	L3	Ø K	H1	H2	H
VXF43..	65	16.9	17	185	118	19 (4x)	86	290	145	145	145	115	231.5	690
	80	20.9	17	200	132	19 (8x)	100	310	155	155	160	115	231.5	690
	100	26.6	17	220	156	19 (8x)	123	350	175	175	180	146	262.5	721
	125	36.5	17	250	184	19 (8x)	149	400	200	200	210	159	275.5	734
	150	53.4	17	284	211	23 (8x)	174	480	240	240	240	186.5	303	762

Spare parts

Stem sealing gland

Product number	DN	Stock number	Comments
VVF43.. VXF43..	DN 65...150	74 284 0061 0	Standard version with FEPM-O-ring for medium temperatures between -5 °C and 220 °C
		4 284 8806 0	When operating with medium temperatures below -5 °C. With the gland 428488060 the valve can be used with water, water with antifreeze and brines between -20 °C and 150 °C.



Revision numbers

Product number	Valid from rev. no.	Product number	Valid from rev. no.
VVF43.65-50	..B	VXF43.65-63	..A
VVF43.65-63	..B	VXF43.80-100	..A
VVF43.80-80	..B	VXF43.100-160	..A
VVF43.80-100	..B	VXF43.125-250	..A
VVF43.100-125	..B	VXF43.150-400	..A
VVF43.100-160	..B		
VVF43.125-200	..B		
VVF43.125-250	..B		
VVF43.150-315	..B		
VVF43.150-400	..B		
VVF43.65-63K	..B		
VVF43.80-100K	..B		
VVF43.100-150K	..B		
VVF43.125-220K	..B		
VVF43.150-315K	..B		