



VVF32..



VXF32..

ACVATIX™

2- and 3-port valves with flanged connections, PN 10

VVF32..
VXF32..

From the large-stroke valve line

- Performance valves for medium temperatures from -10...150 °C
- Valve body of grey cast iron EN-GJL-250
- DN 15...150
- k_{vs} 1.6...400 m³/h
- Flange type 21, flange design B
- Equipable with electro-motoric actuators SAX.. or electro-hydraulic actuators SKD.., SKB.., SKC..

Use











In boiler, district heating and refrigeration plants, heating groups, ventilation and air-handling units as control or shutoff valves.
For use in closed circuits.

Type summary

Valves	Actuators Stroke Positioning force Data sheet				SAX.. ¹⁾		SKD..		SKB..		SKC..	
					20 mm				40 mm			
PN 10					800 N		1000 N		2800 N		2800 N	
					N4501		N4561		N4564		N4566	
	DN	k _{vs}	S _v	Δp_s Δp_{max} Δp_s Δp_{max} Δp_s Δp_{max} Δp_s Δp_{max}								
-10...150 °C	Stock number	[m ³ /h]		[kPa]								
VVF32.15-1.6	S55202-V100	15	1.6	>50	1000	400	1000	400	1000	400	-	-
VVF32.15-2.5	S55202-V101	15	2.5									
VVF32.15-4	S55202-V102	15	4									
VVF32.25-6.3	S55202-V103	25	6.3									
VVF32.25-10	S55202-V104	25	10	>100	550	300	450	200	700	-	-	
VVF32.40-16	S55202-V105	40	16									
VVF32.40-25	S55202-V106	40	25									
VVF32.50-40	S55202-V107	50	40									
VVF32.65-63	S55202-V108	65	63									
VVF32.80-100 ²⁾	S55202-V109	80	100									
VVF32.100-160 ²⁾	S55202-V110	100	160									
VVF32.125-250	S55202-V111	125	250									
VVF32.150-400 ²⁾	S55202-V112	150	400									
											300	250
										190	160	
										125	100	

¹⁾ Suitable for medium temperatures up to 130 °C

²⁾ Valve characteristic for k_{vs} value 100 m³/h from 70% stroke, k_{vs} value 160 m³/h from 85% stroke and k_{vs} value 400 m³/h from 90% stroke is optimized for maximum volumetric flow

Valves	Actuators Stroke Positioning force Data sheet				SAX.. ¹⁾		SKD..		SKB..		SKC..	
					20 mm				40 mm			
PN 10					800 N		1000 N		2800 N		2800 N	
					N4501		N4561		N4564		N4566	
	DN	k _{vs}	S _v	Δp_{max}								
-10...150 °C	Stock number	[m ³ /h]		[kPa]								
												
VXF32.15-1.6	S55202-V113	15	1.6	>50	400	100	400	100	400	100	-	-
VXF32.15-2.5	S55202-V114	15	2.5									
VXF32.15-4	S55202-V115	15	4									
VXF32.25-6.3	S55202-V116	25	6.3									
VXF32.25-10	S55202-V117	25	10	>100	400	100	400	100	400	100	-	-
VXF32.40-16	S55202-V118	40	16									
VXF32.40-25	S55202-V119	40	25									
VXF32.50-40	S55202-V120	50	40									
VXF32.65-63	S55202-V121	65	63									
VXF32.80-100 ²⁾	S55202-V122	80	100									
VXF32.100-160 ²⁾	S55202-V123	100	160									
VXF32.125-250	S55202-V124	125	250									
VXF32.150-400 ²⁾	S55202-V125	150	400									
												250
											160	
											100	

¹⁾ Suitable for medium temperatures up to 130 °C

²⁾ Valve characteristic for k_{vs} value 100 m³/h from 70% stroke, k_{vs} value 160 m³/h from 85% stroke and k_{vs} value 400 m³/h from 90% stroke is optimized for maximum volumetric flow

DN = Nominal size

k_{vs} = Flow nominal value of cold water (5...30 °C) through the fully opened valve (H₁₀₀) at a differential pressure of 100 kPa (1 bar)

S_v = Rangeability

Δp_s = Maximum permissible differential pressure at which the motorized valve still closes securely against the pressure

Δp_{max} = Maximum permissible differential pressure across the valve's throughport for the entire positioning range of the motorized valve

Ordering

Example

Product number	Stock number	Description
VXF32.15-1.6	S55202-V113	3-port valve with flange, PN 10
SKD32.50	SKD32.50	Electro-hydraulic actuator

Delivery

Valves, actuators and accessories are packed and delivered as separate items.

Note

Counter-flanges, bolts and gaskets must be provided on site.

Spare parts, Rev.-No.

See page 12

Equipment combinations

Product number	Description	Stroke	Positioning force	Operating voltage	Positioning signal	Spring return time	Positioning time	LED	Manual adjuster	Auxiliary functions		
SAX31.00	S55150-A105	20 mm	800 N	AC 230 V	3-position	-	120 s	-	Press and fix	1)		
SAX31.03	S55150-A106						30 s	✓			2), 3)	
SAX61.03	S55150-A100			AC 24 V DC 24 V	0...10 V 4...20 mA 0...1000 Ω		120 s	-		1)		
SAX61.03U	S55150-A100-A100						30 s					
SAX81.00	S55150-A102			3-position	-		120 s	-		1)		
SAX81.03	S55150-A103						30 s					
SAX81.03U	S55150-A103-A100											
SKD32.21	SKD32.21	20 mm	1000 N	AC 230 V	3-position	8 s	Opening: 30 s Closing: 10 s	-	Turn, Position is maintained	1)		
SKD32.50	SKD32.50					-	120 s				✓	
SKD32.51	SKD32.51					8 s						
SKD60	SKD60			AC 24 V	0...10 V 4...20 mA 0...1000 Ω	-	15 s	Opening: 30 s Closing: 15 s		✓	2)	
SKD62	SKD62					3-position						-
SKD62U	SKD62U			8 s								
SKD62UA	SKD62UA										4)	
SKD82.50	SKD82.50			AC 24 V	3-position	-	-	120 s		-	-	1)
SKD82.50U	SKD82.50U											
SKD82.51	SKD82.51											
SKD82.51U	SKD82.51U											
SKB32.50	SKB32.50	20 mm	2800 N	AC 230 V	3-position	-	120 s	-	Turn, Position is maintained	1)		
SKB32.51	SKB32.51					10 s						
SKB60	SKB60			AC 24 V	0...10 V 4...20 mA 0...1000 Ω	-	10 s	Opening: 120 s Closing: 10 s		✓	2)	
SKB62	SKB62					3-position						-
SKB62U	SKB62U			10 s								
SKB62UA	SKB62UA										4)	
SKB82.50	SKB82.50			AC 24 V	3-position	-	-	120 s		-	-	1)
SKB82.50U	SKB82.50U											
SKB82.51	SKB82.51											
SKB82.51U	SKB82.51U											
SKC32.60	SKC32.60	40 mm	2800 N	AC 230 V	3-position	-	120 s	-	Turn, Position is maintained	1)		
SKC32.61	SKC32.61					18 s						
SKC60	SKC60			AC 24 V	0...10 V 4...20 mA 0...1000 Ω	-	20 s	Opening: 120 s Closing: 20 s		✓	2)	
SKC62	SKC62					3-position						-
SKC62U	SKC62U			18 s								
SKC62UA	SKC62UA										4)	
SKC82.60	SKC82.60			AC 24 V	3-position	-	-	120 s		-	-	1)
SKC82.60U	SKC82.60U											
SKC82.61	SKC82.61											
SKC82.61U	SKC82.61U											

- 1) Auxiliary switch, potentiometer
- 2) Position feedback, forced control, selection of valve characteristic
- 3) Optional: sequence control, selection of acting direction
- 4) Plus sequence control, stroke limitation, and selection of acting direction

Product documentation

- Mounting Instructions M4030 74 319 0749 0
- Basic documentation P4030 Contains background information and technical basic knowledge of valves

Technical and mechanical design

The illustrations below show the basic design of the valves. Constructional features, such as the shape of plugs, may differ.

2-port valves

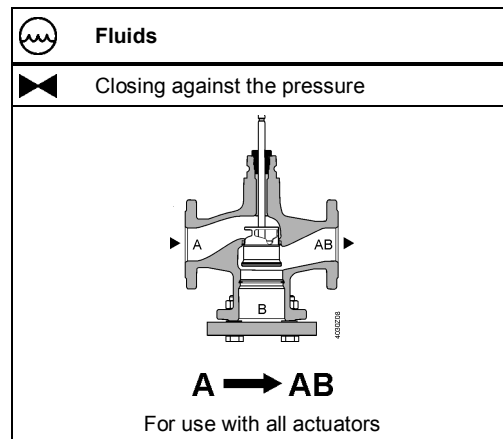

Note

2-port valves do not become 3-port valves by removing the blank flange!

3-port valves

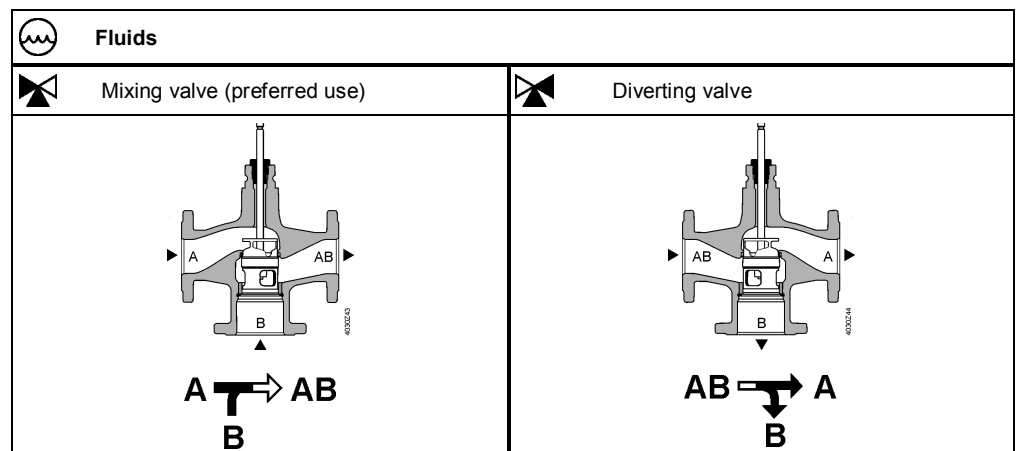

Accessories

Product number	Stock number	Description	Note	Example
ASZ6.5	ASZ6.5	Stem heating element	Required for medium temperatures < 0 °C	
ASZ6.6	S55845-Z108			

Sizing

Flow chart

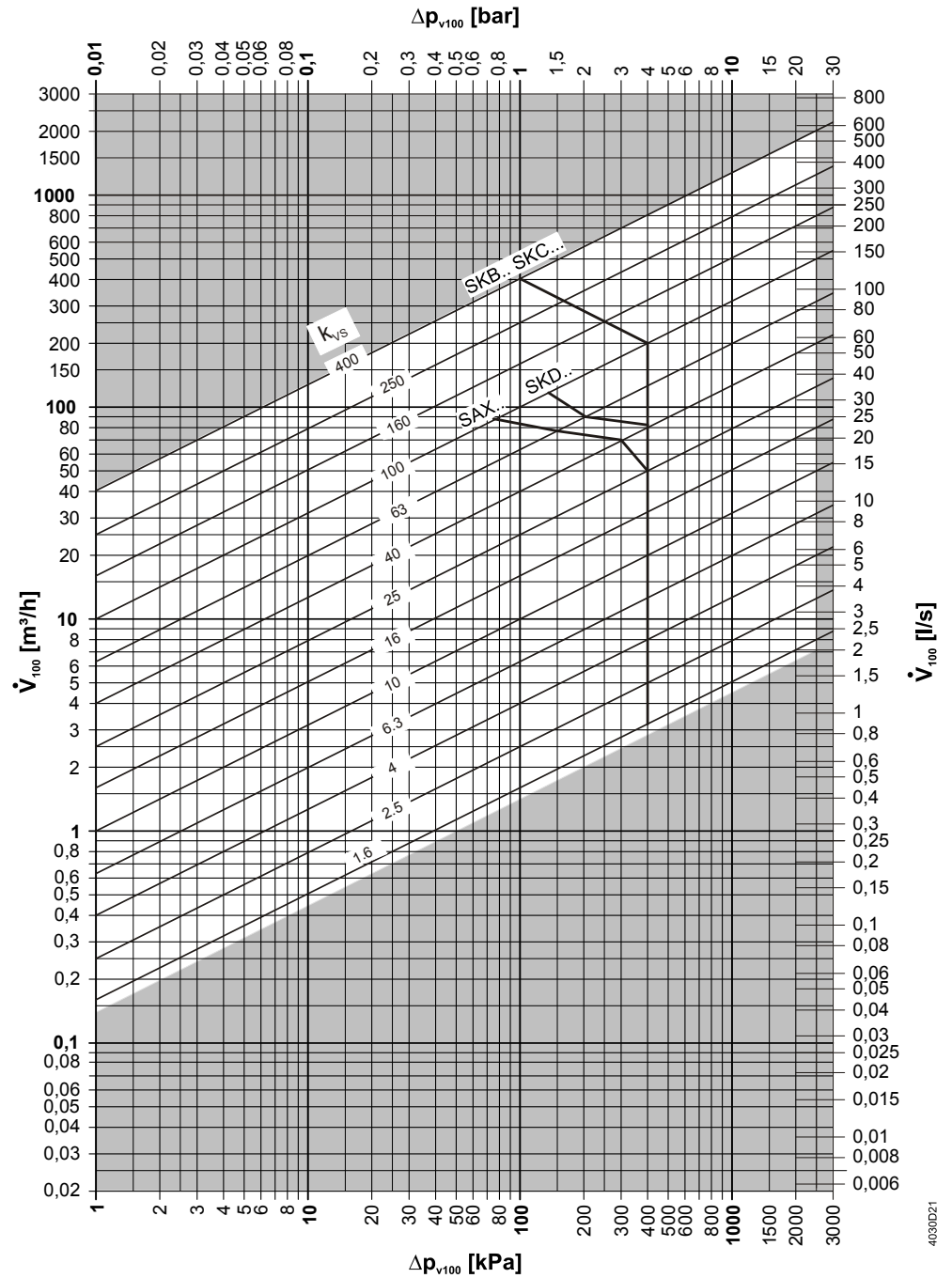

Δp_{\max} values apply for the mixing function. Δp_{\max} values for the diverting function see table „Type summary“, page 2

4030021

Valve characteristics
2-port valves

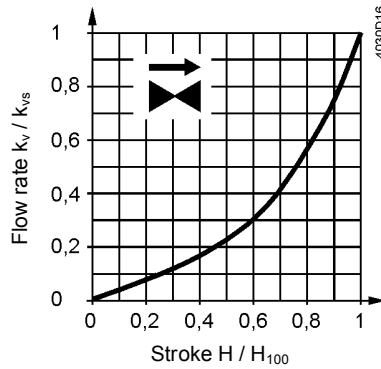

0...30%: Linear
30...100%: Equal percentage
 $n_{gl} = 3$ to VDI / VDE 2173

For high k_{vs} values the valve characteristic is optimized for maximum volumetric flow k_{V100} .

For product lines:
VVF32.125-250
VVF32.150-400

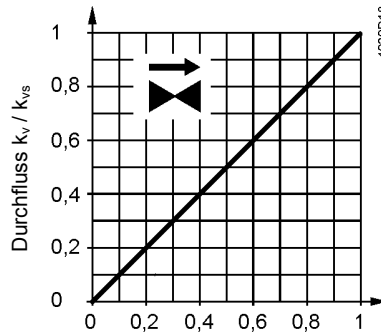

0...100%: Linear

3-port valves

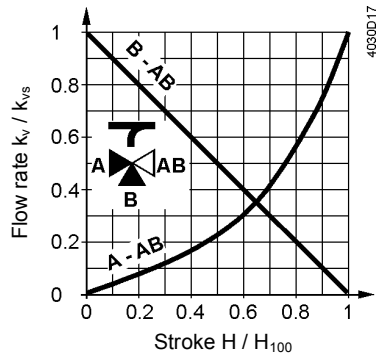

Throughport A-AB

0...30%: Linear
30...100%: Equal percentage
 $n_{gl} = 3$ to VDI / VDE 2173

For high k_{vs} values the valve characteristic is optimized for maximum volumetric flow k_{V100} .

Bypass B-AB

0...100%: Linear
Tor AB = constant flow
Tor A = variable flow
Tor B = bypass (variable flow)

Mixing: Flow from port A and port B to port AB

Diverting: Flow from port AB to port A and port B

For product lines:
VXF32.125-250
VXF32.150-400

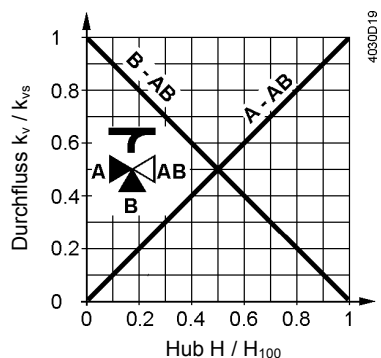

Durchgang A-AB

0...100%: Linear

Bypass B-AB

0...100%: Linear

Operating pressure and medium temperature

Fluids, PN10 with V..F32..

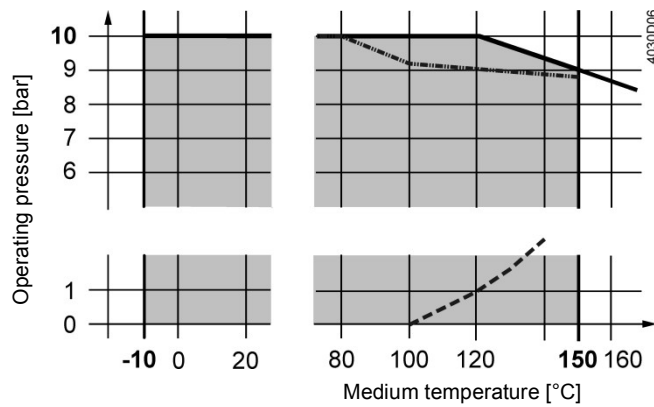

- Curve for saturated steam; steam forms below this line
- .. Operating pressure according to EN 1092, valid for 2-port valves with blank flange

Operating pressure and operating temperatures according to ISO 7005, EN 1092 and EN 12284

Notes

All relevant local directives must be observed

Medium compatibility and temperature ranges

Medium	Temperature range		Valve V..F32..	Note
	T _{min} [°C]	T _{max} [°C]		
Cold water	1	25	■	-
Low-temperature hot water	1	130	■	-
High-temperature hot water ¹⁾	130	150	■	-
Water with antifreeze	-5	150	■	For medium temperatures below 0 °C, the stem heating ASZ6.6 has to be installed.
	-10	150	■	
	-20	150	-	
Brines	-5	150	■	For medium temperatures below 0 °C, the stem heating ASZ6.6 has to be installed.
	-10	150	■	
	-20	150	-	
Deminerlized water according to VDI2035 / SWKI_BT102-01	1	150	■	

¹⁾ Differentiation due to saturated steam curve

Fields of use

Fields of use		Valves	
		VVF32..	VXF32..
Generation	Boiler plants	■	■
	District heating plants	■	-
	Refrigeration plants	■	■
Distribution	Heating groups	■	■
	Ventilation and air-handling units	■	■

Engineering notes

Mounting location	Preferably mount the valves at the return, as the temperature is lower there and the stem sealing gland is less strained.
Dirt trap	Mount a dirt filter or dirt trap before the valve to ensure proper functioning, and a long service life of the valve. Remove dirt, welding beads, etc. from the valves and pipes.
Cavitation	Cavitation can be avoided by limiting the pressure differential across the valve depending on the medium temperature and prepressure.

Mounting notes

Mounting position

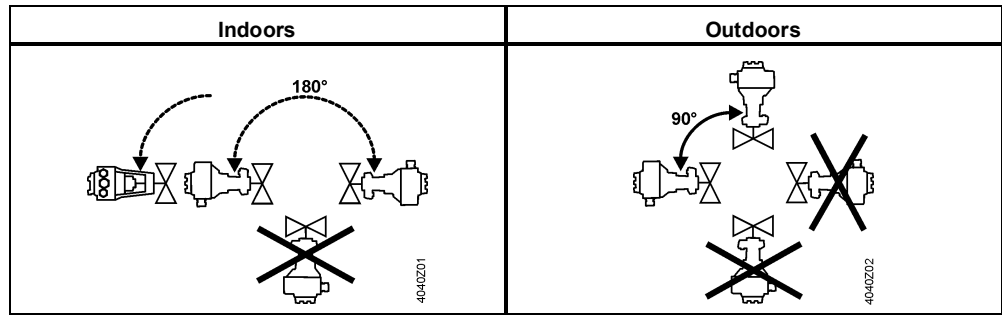

Mounting positions apply to both 2- and 3-port valves.

Commissioning notes



The valve may be put into operation only if actuator and valve are correctly assembled.

Note

Ensure that actuator stem and valve stem are rigidly connected in all positions.

Function check

Valve	Throughport A→AB	Bypass B→AB
Valve stem extends	Closes	Opens
Valve stem retracts	Opens	Closes

Maintenance notes

The valves are maintenance-free.



When servicing valves or actuators:

- Deactivate the pump and turn off the power supply
- Close the shutoff valves
- Fully reduce the pressure in the piping system and allow pipes to completely cool down

If necessary, disconnect the electrical wires.

Due to the different types of material used, the valve must be disassembled prior to disposal. Special handling of certain valve components may be required by law or may be sensible from an ecological point of view.

Local and currently valid legislation must be observed.

Disposal



Warranty

Application-related technical data are guaranteed only when the valves are used in connection with the Siemens actuators listed under "Equipment combinations", page 3.

When used with actuators of other manufacture, any warranty by Siemens becomes void.

Technical data

Functional data	PN class	PN 10	
	Connection	Flange	
	Operating pressure	See Section "Operating pressure and medium temperatures", page 7	
	Valve characteristics ¹⁾	See section "Valve characteristics", page 6	
	Leakage rate	Throughport	0...0.02% of k_{VS} value
		Bypass	0.5...2% of k_{VS} value ($k_{VS} \geq 6.3$) 0.5...3% of k_{VS} value (k_{VS} 1.6; 2.5; 4)
	Permissible media	See table "Medium compatibility and temperature ranges", page 7	
	Medium temperature	-10... 150 °C ²⁾	
	Rangeability	To DN 25: > 50	
		From DN 40: >100	
	Nominal stroke	To DN 80: 20 mm From DN 100: 40 mm	
Materials	Valve body	EN-GJL-250	
	Blank flange	VVF.. S235JRG2	
	Valve stem	Stainless steel	
	Seat	Machined	
	Plug	Brass/ Bronze	
	Stem sealing gland	Brass EPDM O-rings PTFE sleeve silicon-free	
Standards	Pressure Equipment Directive	PED 97/23/EC	
	Pressure-carrying accessories	According to article 1, section 2.1.4	
	Fluid group 2	PN 10	
	Without CE certification as per article 3, section 3 (sound engineering practice)	≤DN 80	
	Category I, with CE certification	DN 100...150	
	Category II, with CE certification, notified body identification number 0036	-	
	PN class	ISO 7268	
	Operating pressure	ISO 7005, DIN EN 12284	
	Flanges	ISO 7005	
	Length of flanged valves	DIN EN 558-1, line 1	
	Valve characteristic	VDI 2173 ¹⁾	
	Leakage rate	Throughport, bypass according to EN 60534-4 / EN 1349	
	Water treatment	VDI 2035	

Environmental conditions		
Storage: IEC 60721-3-1	Class	1K3
	Temperature	-15...+55 °C
	Rel. humidity	5...95% r.h.
Transport: IEC 60721-3-2	Class	2K3, 2M2
	Temperature	-30...+65 °C
	Rel. humidity	< 95% r.h.
Operation: IEC 60721-3-3	Class	3K5, 3Z11
	Temperature	-15...+55 °C
	Rel. humidity	5...95% r.h.
Environmental compatibility	ISO 14001 (environment) ISO 9001 (quality) SN 36350 (environmentally compatible products) RL 2002/95/EG (RoHS)	
Dimensions / Weight	Dimensions	See „Dimensions“, page 11
	Weight	See „Dimensions“, page 11

¹⁾ For certain valve lines and high k_{vS} values, the valve characteristic is optimized for maximum volumetric flow k_{V100} .

Dimensions

VVF32..

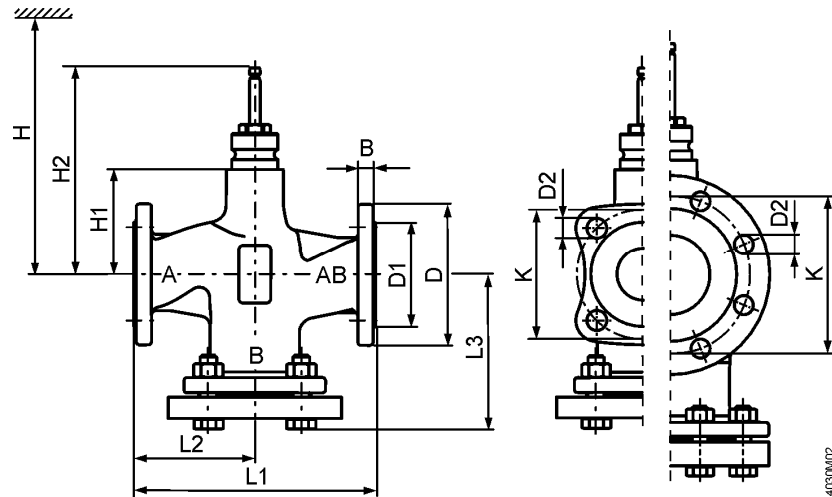

4030M02

Product number	DN	kg	B	Ø D	Ø D1	Ø D2	L1	L2	L3	Ø K	H1	H2	H			
													SAX..	SKD..	SKB..	SKC..
VVF32..	15	3.7	14	95	46	14 (4x)	130	65	86	65	37	133.5	479	537	612	-
	20	-	-	-	-	-	-	-	-	-	-	-	-	-	-	-
	25	5.4	15	115	65	14 (4x)	160	80	104	85	37	133.5	479	537	612	-
	32	-	-	-	-	-	-	-	-	-	-	-	-	-	-	-
	40	9.2	16	150	84	19 (4x)	200	100	126	110	37	133.5	479	537	612	-
	50	12.2	16	165	99	19 (4x)	230	115	143	125	50	146.5	492	550	625	-
	65	17	17	185	118	19 (4x)	290	145	173	145	75	171.5	517	575	650	-
	80	25	17	200	132	19 (8x)	310	155	185	160	75	171.5	517	575	650	-
	100	35.7	17	220	156	19 (8x)	350	175	205	180	110	226.5	-	-	-	685
	125	52.5	17	250	184	19 (8x)	400	200	232	210	123	239.5	-	-	-	698
150	74.3	17	284	211	23 (8x)	480	240	275	240	150.5	267	-	-	-	726	

VXF32..

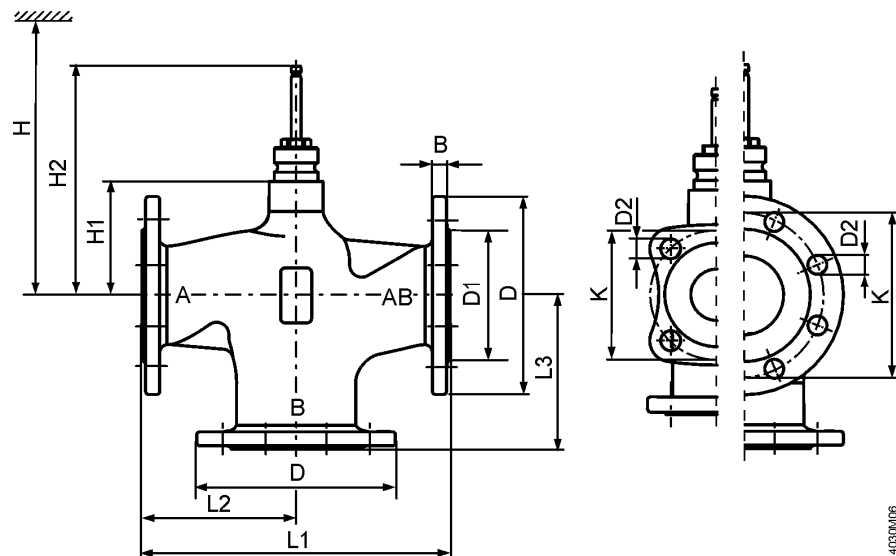

4030M06

Product number	DN	kg	B	Ø D	Ø D1	Ø D2	L1	L2	L3	Ø K	H1	H2	H			
													SAX..	SKD..	SKB..	SKC..
VXF32..	15	2.6	14	95	46	14 (4x)	130	65	65	65	37	133.5	479	537	612	-
	20	-	-	-	-	-	-	-	-	-	-	-	-	-	-	-
	25	3.8	15	115	65	14 (4x)	160	80	80	85	37	133.5	479	537	612	-
	32	-	-	-	-	-	-	-	-	-	-	-	-	-	-	-
	40	6.3	16	150	84	19 (4x)	200	100	100	110	37	133.5	479	537	612	-
	50	8.7	16	165	99	19 (4x)	230	115	115	125	50	146.5	492	550	625	-
	65	12.9	17	185	118	19 (4x)	290	145	145	145	75	171.5	517	575	650	-
	80	19.2	17	200	132	19 (8x)	310	155	155	160	75	171.5	517	575	650	-
	100	28.8	17	220	156	19 (8x)	350	175	175	180	110	226.5	-	-	-	685
	125	43.2	17	250	184	19 (8x)	400	200	200	210	123	239.5	-	-	-	698
	150	61.5	17	284	211	23 (8x)	480	240	240	240	150.5	267	-	-	-	726

Spare parts

Stem sealing gland

Product number	DN	Stock number	Comments	
VVF32.. VXF32..	DN 15...150	4 284 8806 0		

Revision numbers

VVF..
VXF..

Product number	Valid from rev. no.	Product number	Valid from rev. no.
VVF32.15-1.6	..A	VXF32.15-1.6	..A
VVF32.15-2.5	..A	VXF32.15-2.5	..A
VVF32.15-4	..A	VXF32.15-4	..A
VVF32.25-6.3	..A	VXF32.25-6.3	..A
VVF32.25-10	..A	VXF32.25-10	..A
VVF32.40-16	..A	VXF32.40-16	..A
VVF32.40-25	..A	VXF32.40-25	..A
VVF32.50-40	..A	VXF32.50-40	..A
VVF32.65-63	..A	VXF32.65-63	..A
VVF32.80-100	..A	VXF32.80-100	..A
VVF32.100-160	..A	VXF32.100-160	..A
VVF32.125-250	..A	VXF32.125-250	..A
VVF32.150-400	..A	VXF32.150-400	..A